

**CONSTRUCTION OF SANITATION FACILITIES
FOR NEW OR RENOVATED HOMES
AT SCATTERED SITES ON THE
MILLE LACS INDIAN RESERVATION
MILLE LACS, KANEBEC, AITKIN, AND PINE COUNTIES, MINNESOTA**

BE 18-L42

NAME

BID SCHEDULE

Schedule A - Well and Water Pressure System

ITEM NO.	DESCRIPTION	EST QTY	UNIT	UNIT COST	TOTAL COST
1.	Well Drilling for 6" Casing	150	FT	_____	_____
2.	6" Steel Well Casing	145	FT	_____	_____
3.	6" Stainless Steel Screen	5	FT	_____	_____
4.	Gravel Pack	10	FT	_____	_____
5.	Well Development	2	HR	_____	_____
6.	Grouting	50	FT	_____	_____
7.	Test for Yield, Sediment and Drawdown	1	HR	_____	_____
8.	Chemical and Bacteriological Analysis: Bacti, Nitrate, Arsenic, Iron, Manganese, Hardness	1	EA	_____	_____
9.	1/2 HP Submersible Pump	1	EA	_____	_____
10.	Submersible Pump Cable	50	FT	_____	_____
11.	1" PE Drop Pipe w/Fittings	50	FT	_____	_____
12.	1" PE Water Service Line	50	FT	_____	_____
13.	3/4" Copper Tubing	5	FT	_____	_____
14.	Pressure Tank	1	EA	_____	_____
15.	Household Bacteriological Test	1	EA	_____	_____
16.	Buried Cable	50	FT	_____	_____
17.	Pitless Adapter and Cap	1	EA	_____	_____
18.	Well Permit	1	EA	_____	_____
Subtotal Schedule A				_____	_____

Contractor's Authorized Signature

POINTS ARE BASED ON THE NATIONAL
MERCATORIAN VERTICAL DATUM OF 1929
MARK IS A SPIKE IN A 30" OAK
ELEVATION = 1261.57

NOTES FOUND IRON MONUMENT
NOTES POWER POLE
NOTES TELEPHONE PEDESTAL
NOTES DECIDUOUS TREE

ELEVATION=1253.53

MILLE LACS LAKE

HIGH WATER

N79°12'26"E 151.28

TOTAL AREA = 23,295± SQ.Ft.

87' 13

12

11

BM 100.00

SETBACK LINE(TYP)

LP TANK
OVER LINE

SHALLOW
well

LP TANK

BEACH ROAD

S02°01'07"W 163±

118.28

S02°01'07"W 148±

SHALLOW
well

DECK

WELL

62'

11'

51.3

129'

149'

102.70

TAILOR ROAD

S75°20'00"W 154.00 (PLAT = 153.90)

BITUMINOUS
SURFACE

OVERHEAD
C LINE NO

2-2000 GAL TANKS

Location of New
Holding Tank

Proposed Location
of New Well

SITE PLAN
NEW RESIDENC

**CONSTRUCTION OF SANITATION FACILITIES
FOR
NEW OR RENOVATED HOMES
AT
SCATTERED SITES
ON THE
MILLE LACS INDIAN RESERVATION
MILLE LACS, KANEPEC, AITKIN, AND PINE COUNTIES, MINNESOTA
PROJECT BE-18-L42
NAME
DRAWINGS AND SPECIFICATIONS**

**U.S. DEPARTMENT OF HEALTH AND HUMAN SERVICES
PUBLIC HEALTH SERVICE
INDIAN HEALTH SERVICE
OFFICE OF ENVIRONMENTAL HEALTH
AND ENGINEERING
BEMIDJI AREA OFFICE**

SPECIFICATION INDEX

<u>SECTION NUMBER</u>	<u>TITLE</u>
01100	Summary of Work
01270	Price and Payment
01300	Administrative Requirements
01310	Project Management and Coordination
01330	Submittal Procedure
01420	References
01430	Quality Assurance
01500	Temporary Facilities and Controls
01770	Closeout Procedures
01780	Closeout Submittals
02310	Grading
02315	Excavation, Trenching, and Backfill
02370	Temporary Erosion and Sediment Control
02512	Individual Water Systems
02525	Individual Well Drilling
02528	Well Abandonment
02920	Topsoiling, Seeding, Fertilizing, and Mulching

**SECTION 01100
SUMMARY OF WORK**

PART 1 - GENERAL

1.01 SUMMARY

- A. The work to be performed under this contract shall consist of furnishing the following to perform the work outlined in these specifications and as indicated by Project Drawings:
 - 1. tools
 - 2. equipment
 - 3. materials
 - 4. labor
 - 5. supplies
 - 6. manufactured articles
 - 7. all transportation to complete the work
 - 8. temporary facilities

- B. Location of Work: NAME, ADDRESS, Pine City, Pine County, Minnesota, for the Mille Lacs Band of Ojibwe

- C. Incidentals Items: All work, materials, and services not expressly listed as being provided by others or not expressly called for in the contract but are necessary for the completion of the work in good faith, shall be furnished, installed, and performed by the contractor.

1.02 SUMMARY OF WORK TO BE DONE BY CONTRACTOR

- A. Individual Water Facilities
 - 1. Drill and case a 6" well.
 - 2. Chemical and Bacteriological Analysis.
 - 3. Install 1-inch PE Water Service Line.
 - 4. Install Pressure System.
 - 5. Install per design, drawings and specifications
 - 6. Acquire Well Permit

1.03 ADDITIONAL INFORMATION

- A. For information regarding the technical aspects of the project, contact the Engineer:

Anthony LaFontain
Indian Health Service

705 5th Street NW, Suite E
Bemidji, MN 56601
Telephone: (218)-444-0527

- B. For information regarding contracting information, contact the Owner's Representative for this project:

Brian Scheinost
Public Works Administrator
Mille Lacs Public Works
43408 Oodena Drive
Onamia, MN 56359
Telephone: (320) 532-7437

- C. Comply with all Tribal regulations related to the completion of the work including the acquisition of necessary permits and the payment of Tribal taxes.

1.04 WARRANTY

- A. Provide a minimum one (1) year warranty for all materials and labor, covering defects in the materials or deficiencies resulting from Contractor installation and materials.

1.05 ADDITIONAL REQUIREMENTS

- A. Contractor shall be licensed and insured.

END OF SECTION

**SECTION 01270
PRICE AND PAYMENT**

PART 1 - GENERAL

1.01 SUMMARY

- A. Work covered by this section includes method of measurement and basis of payment for all divisions included.
- B. Payment for the various items of the Bid Schedules, as further specified herein, shall include all compensation to be received by the Contractor for furnishing all tools, equipment, materials, labor, supplies, manufactured articles, transportation, and temporary facilities required to complete the work in accordance with contract documents including incidentals.
- C. Respective prices and payment shall constitute full compensation for all work completed including incidentals.
- D. All items not expressly listed as being provided by others that are necessary for the completion of work shall be furnished and installed by the Contractor.
- E. No payment shall be made for mobilization and demobilization of equipment.

1.02 ESTIMATED QUANTITIES

- A. All quantities stipulated in the bid schedule or other contract documents are approximate and are to be used: (1) as a basis for estimating the probable cost of the work and (2) for the purpose of comparing the bids submitted.
- B. The Contractor shall be paid for actual quantities installed based on the quantities measured in the field. The actual amounts of work completed and materials furnished may differ from estimated quantities. The Contractor shall make no claim for damages, anticipated profits, or otherwise, on account of differences between the estimated amounts and the actual amount of work performed and materials furnished.

1.03 SURVEY AND MEASUREMENTS

- A. All quantity measurements shall be the responsibility of the Contractor and will be verified by the Engineer.
- B. All measurements and subsequent payments will be based on completed and accepted work performed in strict accordance with the drawings, specifications, and other contract documents.

PART 2 – BID SCHEDULE ITEMS

2.01 GENERAL

- A. Payment shall be full compensation to complete the work items in good faith, including incidental work.
- B. In addition to the those things listed under each item, the unit price bid shall be full compensation for all of the following:
 - 1. General requirements in Division 01, but not limited to the following.
 - a. Submittals
 - b. Record drawings
 - 2. Specific requirements in Division 02, including but not limited to the following (unless otherwise expressly defined as a line item in the bid schedule):
 - a. Erosion control
 - b. Clearing and grubbing
 - c. Removal and replacement of obstructions
 - d. Associated trenching, excavation and backfill including the removal of any nuisance water, bedding, haunching, and compaction.
 - e. Disposal of any excess material
 - f. Traffic control
 - g. Rough grading
 - h. Finish work, where called for, including finish grading, topsoiling, and landscaping

2.02 BID ITEMS

- A. Well and Water Pressure System
 - 1. Well Drilling for 6" Casing:
 - a. Measurement: By the vertical foot from the ground surface to the bottom of the casing.
 - b. Basis for Payment: Includes drilling and all associated cleanup for a completed well and/or for wells drilled that have to be abandoned when the contractor is determined not to be at fault.
 - 2. 6" Steel Well Casing:
 - a. Measurement: By the vertical foot from 2 feet above the ground to the top of the well screen.
 - b. Basis for Payment: Includes casing in completed wells and well casing not removed from abandoned wells that are determined not to be the fault of the contractor.

3. 6" Stainless Steel Well Screen:
 - a. Measurement: By the vertical foot.
 - b. Basis for Payment: Includes continuous slot well screen, seals, couplings, and riser pipe.
4. Gravel Pack:
 - a. Measurement: By the vertical foot.
 - b. Basis for Payment: Includes material and placement of gravel pack.
5. Well Development:
 - a. Measurement: By the hour for the actual period spent developing the well.
 - b. Basis for Payment: Includes equipment set up, development, and removal of development equipment. Time spent on mobilizing equipment will be incidental to the contract.
6. Grouting:
 - a. Measurement: By the vertical foot.
 - b. Basis for Payment: Includes placement of grout of the thickness required to fill the annular space from the bottom of the casing or the top of the gravel pack to the base of the pitless adapter or unit. Additional depth shall be prior approved.
7. Test for Yield, Sediment and Drawdown:
 - a. Measurement: By the hour.
 - b. Basis for Payment: Includes test pumping and the collection of drawdown and recovery measurements. Payment will only be made after the test pump results have been submitted to the Project Engineer.
8. Well Chemical and Bacteriological Analysis: Bacti, Nitrate, Arsenic, Iron, Manganese, Hardness:
 - a. Measurement: By the unit for each home site.
 - b. Basis for Payment: Includes collection of samples, completion of chemical analyses, disinfection of well and bacteriological testing. Payment may be withheld from future payments for well construction where a negative bacteriological test cannot be obtained. Payment will only be made after the chemical analysis and negative bacteriological test results have been submitted to the Project Engineer.
9. 1/2 HP Submersible Pump:
 - a. Measurement: Each unit installed.
 - b. Basis for Payment: Payment shall be full compensation for pump, fittings, and check valve.

10. Submersible Pump Cable:
 - a. Measurement: Vertical feet of submersible cable measured from the pump to the top of the casing.
 - b. Basis for Payment: Payment shall be full compensation for cable, cable ties, fittings, and splices

11. 1-inch Drop Pipe and Fittings:
 - a. Measurement: Vertical feet of drop pipe from the pump to the pitless adapter/pitless unit.
 - b. Basis for Payment: Payment shall be full compensation for pipe, connections, and fittings.

12. 1-Inch PE Water Service Line:
 - a. Measurement: Linear feet of pipe measured horizontally over the centerline of the pipe.
 - b. Basis for Payment: Payment shall be full compensation for pipe, fittings, connections, excavation, trenching, bedding, haunching, backfill, compaction, grading, and site restoration.

13. $\frac{3}{4}$ -inch Copper Tubing:
 - a. Measurement: Linear feet of pipe measured horizontally over the centerline of the pipe.
 - b. Basis for Payment: Payment shall be full compensation for pipe, fittings and connections.

14. Pressure Tank:
 - a. Measurement: Each unit installed.
 - b. Basis for Payment: Payment shall be full compensation for pipe, fittings, connections, pressure tank, pressure switch, and pump controller.

15. Household Bacteriological Analysis:
 - a. Measurement: By the unit for each home site.
 - b. Basis for Payment: Includes collection of samples, completion of household bacteriological testing. Payment may be withheld from future payments for water pressure system where a negative bacteriological test cannot be obtained. Payment will only be made after the negative bacteriological test results have been submitted to the Project Engineer.

16. Buried Cable:
 - a. Measurement: Linear feet of cable measured horizontally over the centerline of the cable.
 - b. Basis for Payment: Payment shall be full compensation for cable, splices, conduit, excavation, trenching, bedding, backfill, compaction, grading, and site restoration.

17. Pitless Adapter and Cap:
 - a. Measurement: Each unit installed including both the pitless adapter and well cap.
 - b. Basis for Payment: Payment shall be full compensation for pitless adapter and cap.

18. Well Permit:
 - a. Measurement: Each permit obtained.
 - b. Basis for Payment: Payment shall include full compensation for submitting application forms to the Minnesota Department of Health, and payment of the necessary fees to obtain the permit.

PART 3 – EXECUTION (N/A)

END OF SECTION



This Page Intentionally Left Blank

SECTION 01300
ADMINISTRATIVE REQUIREMENTS

PART 1 - GENERAL

1.01 SUMMARY

- A. Section includes the administrative notes and requirements for this contract.

1.02 For all contracts:

- A. The Indian Health Service (IHS) is the engineer for this project; however, this is not a federal contract. IHS reserves the right to inspect the work performed by the Contractor or any of its Subcontractors. IHS does not represent the Tribe and the Tribe does not represent IHS regarding any matter related to administration of this Contract.
- B. IHS Indian preference requirements apply to the solicitation and award of this contract. If the tribe has enacted an Indian preference ordinance, it may apply in lieu of the IHS requirements.

C. SUSPENSION AND TERMINATION OF WORK

1. At any time and without cause, Owner may suspend the Work or any portion thereof for a period of not more than 90 consecutive days by written notice to Contractor and Engineer. Such notice will fix the date on which Work will be resumed. Contractor shall resume the Work on the date so fixed. Contractor shall be entitled to an adjustment in the Contract Price or an extension of the Contract Times, or both, directly attributable to any such suspension. Any change proposal seeking such adjustments shall be submitted no later than 30 days after the date fixed for resumption of Work.
2. If the Contractor fails to perform the work in accordance with the Contract Documents, Owner may declare the Contractor to be in default and give Contractor notice that the Contract is terminated. The termination will not affect any rights or remedies of Owner against Contractor then existing or which may thereafter accrue, or any rights or remedies of Owner against Contractor.
3. Upon seven days written notice to Contractor and Engineer, Owner may, without cause and without prejudice to any other right or remedy of Owner, terminate the Contract. In such case, Contractor shall be paid for completed and acceptable work executed in accordance with the Contract Documents prior to the effective date of termination. Contractor shall not be paid on account of loss of anticipated overhead, profits, or revenue, or other economic loss arising out of or resulting from such termination.

- D. Contractor shall comply with 41 CFR 60-1.4(b) in accordance with Executive Order 11246, "Equal Employment Opportunity," as amended by Executive Order 11375, "Amending Executive Order 11246 Relating to Equal Employment Opportunity.
- E. Debarment and Suspension (Executive Orders 12549 and 12689)—A contract award (see 2 CFR 180.220) must not be made to parties listed on the government-wide exclusions in the System for Award Management (SAM), in accordance with the OMB guidelines at 2 CFR part 180 that implement Executive Orders 12549 (3 CFR part 1986 Comp., p. 189) and 12689 (3 CFR part 1989 Comp., p. 235), "Debarment and Suspension." SAM Exclusions contains the names of parties debarred, suspended, or otherwise excluded by agencies, as well as parties declared ineligible under statutory or regulatory authority other than Executive Order 12549.
- F. Contractor is required to perform thirty-three and one-third percent of the total amount of the Work using its own employees and equipment. Copies of subcontract agreements may be requested to verify the amount of Work performed.

1.03 For Contracts Exceeding \$2,000:

- A. The Contractor shall comply with wage and provisions of the Davis-Bacon Act (40 U.S.C. 3141-3148) as supplemented by Department of Labor regulations (29 CFR part 5). In accordance with the statute, Contractors must be required to pay wages to laborers and mechanics at a rate not less than the prevailing wages specified in a wage determination made by the Secretary of Labor.
- B. The Contractor shall comply with the Copeland "Anti-Kickback" Act (40 U.S.C. 3145), as supplemented by Department of Labor regulations (29 CFR part 3). The Act provides that each Contractor or subrecipient must be prohibited from inducing, by any means, any person employed in the construction, completion, or repair of public work, to give up any part of the compensation to which he or she is otherwise entitled.

1.04 For Contracts Exceeding \$10,000:

- A. Contractor shall comply with the requirements of 41 CFR 60-4 regarding required notices and procedures to be followed in soliciting for federally assisted construction contracts (including subcontracts). Compliance with Executive Order 11246 and 41 CFR part 60-4 shall be based on implementation of the Equal Opportunity Clause, specific affirmative active obligations required by the Standard Federal Equal Employment Opportunity Construction Contract Specifications, as set forth in 41 CFR Part 60-4.3(a) and efforts to meet the goals established for the geographical area where the Contract is to be performed.

1.05 For Contracts Exceeding \$100,000:

- A. The Contractor shall comply with the provisions of the Work Hours and Safety Standards Act (40 U.S.C. 3701-3708). Under 40 U.S.C. 3702 of the Act, each Contractor must be required to compute the wages of every mechanic and laborer on the basis of a standard work week of 40 hours. Work in excess of the standard work week is permissible provided that the worker is compensated at a rate of not less than one and a half times the basic rate of pay for all hours worked in excess of 40 hours in the work week. The requirements of 40 U.S.C. 3704 are applicable to construction work and provide that no laborer or mechanic must be required to work in surroundings or under working conditions which are unsanitary, hazardous or dangerous.

- B. The Contractor shall comply with the provisions of the Byrd Anti-Lobbying Amendment (31 U.S.C. 1352), certifying that it will not and has not used Federal appropriated funds to pay any person or organization for influencing or attempting to influence an officer or employee of any agency, a member of Congress, officer or employee of Congress, or an employee of a member of Congress in connection with obtaining any Federal contract, grant or any other award.

END OF SECTION



This Page Intentionally Left Blank

**SECTION 01310
PROJECT MANAGEMENT AND COORDINATION**

PART 1 - GENERAL

1.01 SUMMARY

- A. Section includes the preconstruction conference, construction scheduling and coordination requirements.

1.02 PRE-CONSTRUCTION CONFERENCE

- A. Required after award of contract and prior to start of construction.
- B. Representatives from the following shall attend.
 - 1. Prime Contractor
 - 2. Subcontractors
 - 3. Engineer and Technical Representative
 - 4. Owner's Representative
- C. Engineer will arrange a date that is mutually acceptable to all parties planning to attend.
- D. Contractor shall notify subcontractors of time and date of meeting.

1.03 CONSTRUCTION SCHEDULE

- A. Present Owner and Engineer with a written preliminary construction schedule containing start and completion dates of the major items at the preconstruction meeting.
- B. Notify the Owner and Engineer seven (7) days in advance of any construction.
- C. Communicate major changes to the schedule to the Owner and Engineer in writing.

1.04 WORKING HOURS/DAYS

- A. Except as required for safety purposes, all work shall be performed during regularly scheduled working hours. The Contractor shall not work on Saturday, Sunday, or a Federal holiday without the Owner and Engineer's consent.

1.05 COORDINATION WITH OTHER CONTRACTORS/UTILITIES

- A. Coordinate work with other contractors (i.e. roads, building, etc) in the area as necessary to complete the work specified.

- B. Coordinate work with local utilities (i.e. water and sewer, power, telephone).
Note: all buried utilities may not be shown on the plans. Contractor's responsibility for having utilities marked prior to construction.

END OF SECTION

SECTION 01330 SUBMITTAL PROCEDURE

PART 1 - GENERAL

1.01 SUMMARY

- A. This section includes information on submittal procedures. Materials requiring submittal are listed in the appropriate specification section.

1.02 SUBMITTAL PROCEDURES

- A. Submit copies of submittals to the Engineer, unless requested otherwise.
 - 1. Contractor's option:
 - a. Two (2) hard copies.
 - b. An electronic copy in pdf format delivered to Engineer via email or other means as approved by the Engineer.
- B. Identify each cut sheet or shop drawing with the following information:
 - 1. Contract number.
 - 2. Supplier.
 - 3. Specification section to which the submittal pertains.
- C. Submit the following information, as applicable:
 - 1. Manufacturer's cut sheets indicating compliance with references (e.g. applicable ASTM, AWWA standards).
 - 2. Laboratory results, as applicable.
 - 3. Dimensional drawings or shop drawings, as applicable.
 - 4. Other information necessary for the Engineer to determine compliance with the specifications.
 - 5. Clearly identify brand, manufacturer, model number, sizes, and all other information on each cut sheet to identify the exact product being submitted for approval.
- D. Identify variations from the contract documents and product or system limitations that may be detrimental to successful performance of the completed work.
- E. Revise and resubmit submittals as required and identify all changes made since previous submittal.
- F. Distribute copies of reviewed submittals to concerned parties, (i.e. suppliers, sub-contractors).

- G. Submit written communication of any inability to comply with the Engineer's comments.
- H. Submit information to the Engineer at least three weeks in advance of the work to be performed.
- I. Approval of submittals must be provided by the Engineer prior to installation of materials.

END OF SECTION

SECTION 01420 REFERENCES

PART 1 - GENERAL

1.01 SUMMARY

- A. This section includes a list of common organizations, associations or appropriate agencies with jurisdiction that have references, standards, laws or regulations cited in these specifications. This list is not all-inclusive. Other agencies (county, local, tribal) with jurisdiction might not be listed here.
- B. Use latest revision of all references, standards, laws or regulations.

1.02 LIST OF ORGANIZATIONS, ASSOCIATIONS & AGENCIES

A. National Standards Organizations & Associations

American Association of State Highway and
Transportation Officials (AASHTO)
444 North Capital Street NW, Suite 249
Washington DC, 20001
(202) 624-5800
www.aashto.org

American Concrete Institute (ACI)
ACI International
PO Box 9094
Farmington Hills, Michigan 48333-9094
(810) 848-3700
www.aci-int.org

American Society for Testing and Materials
(ASTM)
100 bar Harbor Drive
West Conshohocken, Pa 19428-2959
(610) 832-9585
www.astm.org

American Water Works Association AWWA
6666 West Quincy Avenue
Denver, CO 80235
(303) 794-7711
www.awwa.org

National Electric Code (NEC)
National Fire and Protection Association
1 Batterymarch Park
Quincy, MA 02269-9959
1 888 632-2633
www.nec.com

National Electrical Manufacturer's Association
NEMA
1300 North 17th Street
Rosslyn, VA 22209
(703) 841-3200
www.nema.org

Underwriters' Laboratories, Inc. UL
333 Pfingston Road
Northbrook, IL 60062
(847) 272-8800
www.ul.com

B. Federal Agencies

Environmental Protection Agency (EPA)
Region 5
77 West Jackson
Chicago, IL 60604-3507
<http://www.epa.gov/r5water/>

Occupational Health and Safety Administration
Region 5 (OSHA)
238 South Dearborn Street , Room 3244
Chicago, IL 60604
www.osha.gov

C. State Agencies

Minnesota Department of Transportation
(MNDOT)
Transportation Building
395 John Ireland Boulevard
St. Paul, MN 55155
1 800 651-3774
www.dot.state.mn.us

Minnesota Pollution Control Agency (MPCA)
Individual Sewage Treatment System Standard
520 Lafayette Road
St Paul, MN 55155
1 800 657-3864
www.pca.state.mn.us

Minnesota Department of Health
717 Delaware Street South East
Minneapolis, MN 55440-9441
(651) 201-5000
www.health.state.mn.us

D. Local Agencies

1. Contractor shall review other local agency requirements to determine applicability with this project.

E. Tribal Organizations

1. See Section 01100 for appropriate tribal contact regarding tribal laws.

PART 2 – PRODUCTS (N/A)

PART 3 – EXECUTION (N/A)

END OF SECTION

**SECTION 01430
QUALITY ASSURANCE**

PART 1 - GENERAL

1.01 SUMMARY

- A. This section includes prerequisites and procedures to assure the quality of construction.

1.02 SUBMITTALS

- A. Contractor Name and License Number

1.03 INSTALLER QUALIFICATIONS

- A. Work shall be performed under the direction of personnel licensed in the state/reservation where the project is proposed and where licensing of the trade is regulated by the state/reservation including, but not limited to, plumbing, well drilling, septic system installation, HVAC, and electrical work.

1.04 CONTROL OF INSTALLATION

- A. Review materials for acceptability when delivered to the site.
- B. Store and handle materials to prevent damage.
- C. Review materials, services, and workmanship to ensure that work is performed in accordance with the specifications.
- D. Comply fully with manufacturers' instructions.
- E. Should manufacturers' instructions conflict with contract documents, request clarification from Engineer before proceeding.
- F. Correct defective work to the satisfaction of the Project Engineer.

1.05 MANUFACTURER'S FIELD SERVICES

- A. Provide reports on observations and documentation of workmanship to the Engineer within 30 days of visit for review where manufacturers' field services are provided.

1.06 WARRANTY

- A. Provide a minimum one (1) year warranty for all materials and labor, covering defects in the materials or deficiencies resulting from contractor installation.

B. Provide additional warranties as required under other sections.

END OF SECTION

**SECTION 01500
TEMPORARY FACILITIES AND CONTROLS**

PART 1 - GENERAL

1.01 SUMMARY

- A. The work covered by this section includes all temporary facilities and controls needed to complete work under the Contract in a manner that protects public safety and worker safety, that preserves both public and private property and that appropriately involves local governments, emergency and law enforcement.

1.02 RELATED WORK

- A. Section 02315 – Excavation, Trenching and Backfill
- B. Section 02705 – Road Restoration

1.03 REFERENCES

- A. Manual on Uniform Traffic Control Devices

PART 2 – PRODUCTS (NOT APPLICABLE)

PART 3 - EXECUTION

3.01 GENERAL

- 1. Provide temporary facilities and controls that are necessary to carry out the requirements of the Contract in a manner
 - 1. That protects public safety and worker safety
 - 2. That preserves both private and public property
 - 3. That communicates and cooperates with local authorities and governments.

3.02 TEMPORARY WATER (IF APPLICABLE)

- A. If there is an existing building or hydrant on the site from which water can be taken, Contractor may use the available water if authorized by the Owner.
- B. If the Owner has water supply mains, but no hydrant is available, Contractor may make a water main tap and create a service line if authorized by the Owner.

- C. If the Owner does not have a water supply, make arrangements to obtain water and pay for it at no direct cost to the project.
- D. Cross Connection Control: When connecting to the Owner's water supply, provide appropriate backflow prevention devices in accordance with State codes and the Owner's requirements.

3.03 TEMPORARY SANITARY FACILITIES

- A. Provide and maintain a chemical toilet approved by the State Department of Health (MN) for the use of all workers of all trades.
- B. Place temporary facilities in an inconspicuous place and keep clean.
- C. Remove temporary sanitary facilities after completion of the project.

3.04 BARRICADES & WARNING DEVICES

- A. Notify local police, fire departments and other emergency programs of any proposed barricading or detouring.
- B. Erect and maintain barricades, guardrails, lights and signs as necessary for public convenience and safety.
- C. Ensure that barricades remain in place during critical hours.
- D. Comply with "Occupational Safety and Health Act" and local safety requirements, as they apply.

3.05 TRAFFIC CONTROL

- A. Conduct all traffic control operations in accordance with the latest issues of the "Manual On Uniform Traffic Control Devices" (MUTCD).
- B. Coordinate and obtain approval for all traffic control from local law enforcement.
- C. Signs, Signals and Devices
 - 1. Place warning signs in the region of the work.
 - 2. Warn of types of conditions that may be encountered.
 - a. Muddy Roads
 - b. Slippery Roads
 - c. Flagman
 - d. Detour
 - e. Slow Moving Traffic

- f. Trucks Entering Roadway
- 3. Traffic Control Signals: Meet the needs of the local government authority.
- 4. Traffic Cones and Drums, Flares and Lights:
 - a. Meet the needs of the local jurisdictions.
 - b. Use flares and lights during hours of low visibility to delineate traffic lanes and to guide traffic.
 - c. Ensure that flares, lights, etc. remain in position throughout the night.
- 5. Flagman:
 - a. Meet the needs of the local jurisdictions.
 - b. Provide trained and equipped flagmen to regulate traffic when construction operations or traffic encroach on public traffic lanes.
- C. Haul Routes:
 - 1. Consult with authority having jurisdiction in establishing public thoroughfares to be used for haul routes and site access.
 - 2. Confine construction traffic to designated haul routes.
 - 3. Provide traffic control at critical areas of haul routes to regulate traffic, to minimize interference with public traffic.
- D. Removal of Traffic Control:
 - 1. Remove equipment and devices when no longer required.
 - 2. Repair damage caused by installation.

3.06 ACCESS ROADS

- A. Construct and maintain temporary roads accessing public thoroughfares to serve construction area.
- B. Provide detours necessary for unimpeded traffic flow.
- C. Provide and maintain access to fire hydrants, free of obstructions.
- D. Permanent access roads and parking areas, if applicable, will be covered in Division 2, Site Work.

3.07 PARKING

- A. If the site is large enough, the Contractor may park their own and employees' vehicles on the site without charge after obtaining permission from the Owner.
- B. If the site is not large enough, the Contractor shall make parking arrangements.
- C. Prevent interference with the flow of local traffic.
- D. Prevent interference with emergency vehicle functions.

3.08 ROAD SURFACE MAINTENANCE

- A. Remove mud and excavated spoils from the affected roadway at the end of each workday in order to preserve the roadways and maintain safe driving conditions.
- B. Contractor is responsible for any costs associated with repairing the roadways that are damaged due to construction equipment.

3.09 WATER CONTROL

- A. Grade site to drain.
- B. Protect site from puddling or running water.
- C. Provide water barriers as required to protect site from soil erosion.

3.10 DUST CONTROL

- A. Use measures to minimize dust caused by the project.
- B. Avoid dust-creating activities during dry, windy conditions.

3.11 SECURITY

- A. The Owner will **not** be responsible for security on the site of work.
- B. Each Contractor will be held responsible for loss or injury to persons or property where their work is involved.
- C. Provide (if deemed necessary) such watchmen and take such other precautionary measures as deemed necessary to protect facilities during the contract period.

3.12 PROGRESS CLEANING

- A. Maintain areas free of waste materials, debris and rubbish. Maintain site in a clean and orderly condition.
- B. Remove waste materials, debris, and rubbish from site weekly and dispose off-site.

3.13 REMOVAL OF UTILITIES, FACILITIES & CONTROLS

- A. Remove temporary above grade or buried utilities, equipment, facilities, materials, prior to inspection.
- B. Clean and repair damage caused by installation or use of temporary work.
- C. Restore existing facilities used during construction to original condition.

3.14 TEMPORARY FIRST AID FACILITIES

- A. Provide temporary first aid facilities for employees in sufficient quantity for the number of workers.

3.15 TEMPORARY FIRE PROTECTION

- A. Post fire department telephone numbers at the jobsite.
- B. Keep fire extinguishers on the job that are appropriate for the type of work being performed.

END OF SECTION



This Page Intentionally Left Blank

**SECTION 01770
CLOSEOUT PROCEDURES**

PART 1 - GENERAL

1.01 SUMMARY

- A. Section includes information on closeout procedures and final cleaning.

1.02 RELATED WORK

- A. Section 01780 – Closeout Submittals

1.03 CLOSEOUT PROCEDURES

- A. Submit written certification that work is complete in accordance with contract documents and ready for final inspection at least three (3) working days prior to final inspection.
- B. Provide warranties and record documents (e.g. as-built drawings) to the Engineer that are required within ten (10) days after date of first beneficial use. Refer to Section 01780.

1.04 FINAL CLEANING

- A. Complete final clean-up prior to final inspection.
- B. Remove waste and surplus materials, rubbish, and construction facilities from the site.

1.05 FINAL INSPECTION

- A. A final inspection of the facilities shall be conducted in the presence of the Owner, the Engineer, and the Contractor, at a minimum.
- B. Final inspection shall include inspection of all facilities installed under the project.

1.06 PUNCH LIST

- A. Any deficiencies noted at the Final Inspection will be communicated to the Contractor through a letter from the Engineer.
- B. All deficiencies will need to be completed before full payment is made.
- C. Retainage for punch list items shall be based on the estimated cost to retain another contractor to finish the deficient work items.

END OF SECTION



This Page Intentionally Left Blank

**SECTION 01780
CLOSEOUT SUBMITTALS**

PART 1 - GENERAL

1.01 SUMMARY

- A. This section describes the requirements for closeout submittals including, record drawings, warranty information and general operation and maintenance information.

1.02 RELATED WORK

- A. Section 01430 – Quality Assurance
- B. Section 01770 – Closeout Procedures
- C. Section 01785 – Operation and Maintenance Manuals (If applicable)

1.03 DELIVERY

- A. Provide all closeout submittals meeting these requirements and any specific requirements of each section.
- B. Closeout submittals must be received before payment is requested for the work that the drawings describe or illustrate.
- C. All closeout submittals must be received in a correct and complete manner before final payment can be made. If material is deficient, the deficiencies will be indicated in punch lists (Section 01770).

1.04 DEFINITIONS

- A. Record Drawing: A drawing showing the actual installation of facilities, showing changes from the plans, and showing detail enough that future persons can readily locate all objects.
- B. Ties: Measurements from permanent easily located objects to an installed object.

PART 2 – PRODUCTS (NOT APPLICABLE)

PART 3 - EXECUTION

3.01 RECORD DRAWINGS

- A. Provide record data in one of the following manners:

1. On a set of project drawings, neatly draw tie measurements and changes.
 2. On separate 8½ X 11 sheets (see 01780D – Closeout Submittal Drawings), neatly draw site sketches, structure sketches, etc., indicating the necessary information.
- B. Provide three (3) swing tie measurements to all buried utility objects that may need to be located in the future, including, but not limited to:
1. Gate valves
 2. Corporation stops
 3. Curb stops
 4. Water main fittings
 5. Couplings to existing water systems.
 6. Cleanouts
 7. Sewer wyes.
 8. Utility crossings.
 9. Septic tank manholes and access covers.
 10. Corners of drainfields
 11. Tracer Wire Boxes
- C. Provide offset measurements for buried utilities (e.g. water main) installed parallel to roads.
- D. Provide revised elevation data for all items that have elevations shown on the plan drawings, including, but not limited to, the following:
1. Manhole inverts (inlet and outlet)
 2. Manhole rims
 3. Lift station invert
 4. Lift station top
 5. Lift station pipe penetrations
 6. Float elevations
 7. Septic tank elevations
 8. Elevations of pipe entering and leaving structures
 9. Elevation of sewer service line stub (if terminated at right of way)
 10. Other elevations indicated on profiles.
- E. Provide installed bid schedule items quantities for individual facilities on 8½ X 11 sheets.
1. Engineer may supply standard forms for use by the Contractor.

3.02 WARRANTIES

- A. Submit all warranty information regarding the materials installed.
- B. Minimum warranty information is listed in Section 01430.

3.03 OPERATION AND MAINTENANCE INFORMATION

- A. Submit all operation and maintenance information as included in the packaging from the manufacturer regarding the materials installed.
- B. Additional project specific operation and maintenance requirements are listed in Section 01785.

END OF SECTION



This Page Intentionally Left Blank

AS-BUILT DRAWING

HOMEOWNER: [NAME]
 PROJECT NO: [IHS PROJECT NO.]
 RESERVATION:
 ADDRESS:
 LEGAL DESCRIPTION:

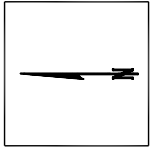

NORTH ARROW

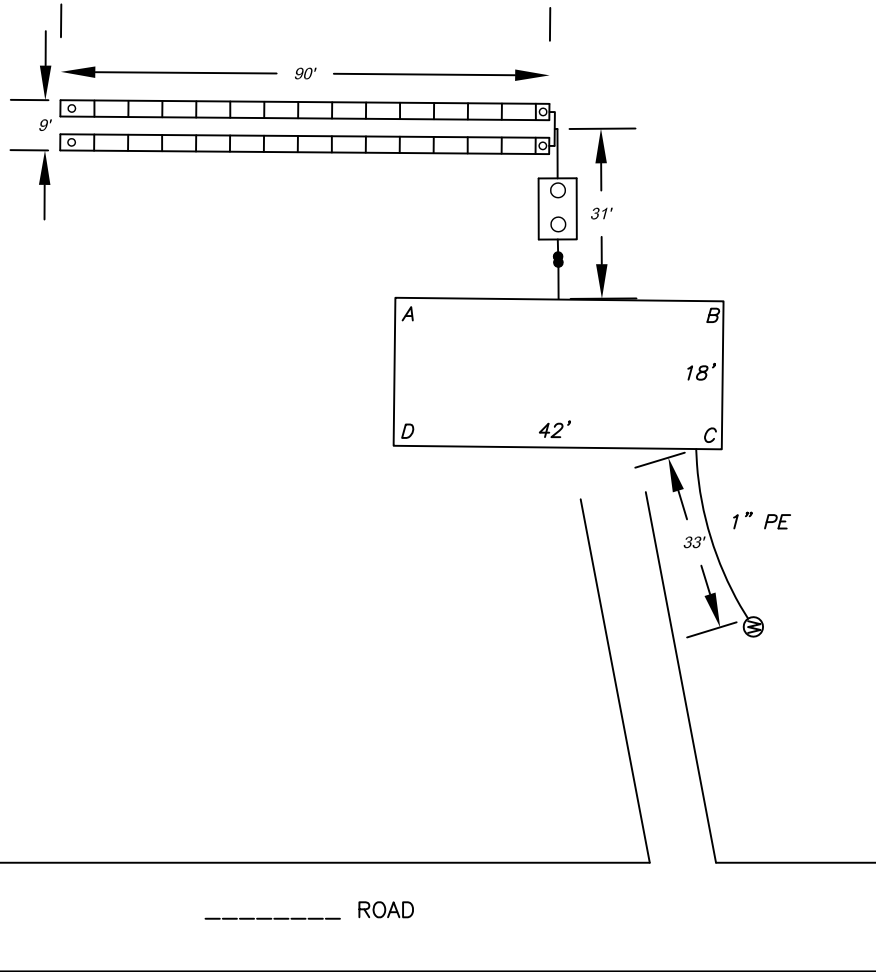

USER: jzierden FILE: I:\STANDARD DETAILS\CSI-SPECS\2012\01780-1.dwg 12/14/2012 - 9:19am

ITEM DESCRIPTION	SYMBOLS	MATERIALS			HOUSE CORNER TIES (FT.)				DRAWN BY: TLR DATE: 02-16-06 COMPANY: ABC COMPANY
		SIZE	MAT'L	QUANT.	A	B	C	D	
CURB STOP	⊙								
WELL	⊕	6"	STEEL	1			33.2'	74.1'	
SEPTIC TANK	□□	1000 GAL	CONCRETE	1	35.0'	35.0'			
COMBINATION SEPTIC/PUMP TANK	□□□ □□-□	GAL			52.0'	52.0'			REMARKS: DRAINFIELD IS DESIGNED FOR A 4 BEDROOM HOME
TWO WAY CLEANOUT	●●	4"	PVC	1	30.7'	30.9'			
ONE WAY CLEANOUT	●				31.2'	31.5'			INSTALLED QUICK4 STANDARD CHAMBERS
FREEZELESS RISER	⊕								
WATER SERVICE LINE	— W —								
SEWER SERVICE LINE	— S —								
DRAIN FIELD	□□□□□		HDPE	42	DISPOSAL SYSTEM				FACILITIES INSTALLED IN FEBRUARY 2006
PERFORATED PIPE	—								
SEWER FORCE MAIN	— SFM —				<input type="checkbox"/> IN-GROUND				
INSULATION	▨▨▨▨▨				<input type="checkbox"/> AT-GRADE				
BURIED ELECTRICAL LINE	— E —				<input type="checkbox"/> MOUND				
WATER MAIN	— W/M —				MATERIAL: INFILTRATOR CHAMBERS				DRAWING NO. 01780-2 (EXAMPLE)
SEWER MAIN	— S/M —				DIMENSIONS: 9' x 90'				

SECTION 02310 GRADING

PART 1 - GENERAL

1.01 SUMMARY

- A. This section includes rough and finished site grading of all areas disturbed during construction.

1.02 RELATED WORK

- A. Section 02315 – Excavation, Trenching and Backfill
- B. Section 02370 – Temporary Erosion and Sediment Control
- C. Section 02920 – Topsoiling, Seeding, Fertilizing and Mulching

PART 2 – PRODUCTS (Not applicable)

PART 3 - EXECUTION

3.01 ROUGH GRADING

- A. Grade the area in the vicinity of the excavation to prevent surface water from flowing into the excavation.
- B. Maintain existing drainage.

3.02 FINISH GRADING

- A. Grade site to true grades as specified on the plans after all structures and piping have been installed.
- B. Grade sites for effective drainage away from structures.
- C. Dress and trim all slopes.

END OF SECTION



This Page Intentionally Left Blank

**SECTION 02315
EXCAVATION, TRENCHING, AND BACKFILL**

PART 1 - GENERAL

1.01 SUMMARY

- A. This section includes excavation, trenching and backfill necessary for the construction of the facilities as indicated on the plans including, but not limited to: water mains and service lines, sewer mains and service lines, concrete manholes, septic tanks, and other structures.

1.02 RELATED WORK (as applicable)

- A. Section 01780 – Closeout Submittals
- B. Section 02310 – Grading
- C. Section 02370 – Temporary Erosion And Sediment Control
- D. Section 02512 – Individual Water Systems
- E. Section 02920 – Topsoiling, Seeding, Fertilization and Mulching

1.03 REFERENCES

- A. Manual on Uniform Traffic Control Devices.
- B. ASTM D698 – Test Methods for Moisture Density Relations of Soils and Soil-Aggregate Mixtures Using 5.5 lb. Rammer and 12-in. Drop [Standard Proctor Test].
- C. ASTM D2321 – Underground installation of Flexible Thermoplastic Sewer Pipe.
- D. ASTM D2487 – Classification of Soils for Engineering Purposes [Unified Soil Classification System].
- E. OSHA – Occupational Safety and Health Standards 1910 and 1926.

1.04 SUBMITTALS

- A. Polystyrene Insulation
- B. Polyethylene Encasement (as applicable)

1.05 DEFINITIONS

- A. Bedding, Haunching and Initial Backfill zones as defined herein and on the standard pipe trench detailed drawing below:

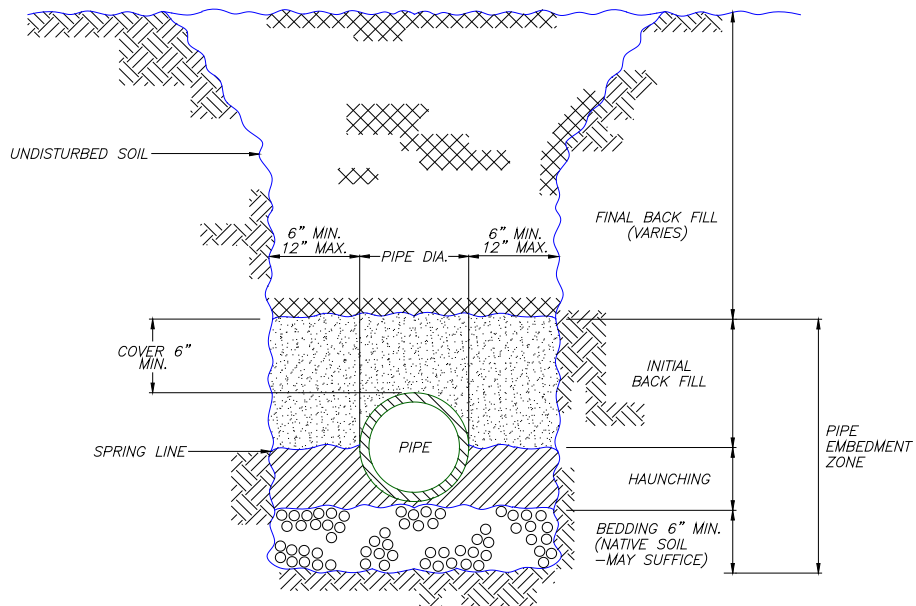

PIPE TRENCH DETAIL

B. Soil Materials as summarized in the table below and defined in ASTM D2321 and ASTM D2487

Description and Comparison of Soil Material Classifications

ASTM D2321		ASTM D2487	
<i>Class</i>	<i>Type</i>	<i>USCS Group Symbol</i>	<i>Description</i>
IA	Manufactured aggregates: ¼ to 1 ½ inch open graded, clean.	* None	Closest to "Poorly graded gravel (GP)"
IB	Manufactured aggregates: ¼ to 1 ½ inch dense graded, clean.	* None	Closest to "Poorly graded gravel with sand (GP)"
II	Coarse sands and gravels with maximum particle size of 1 ½ inch, clean.	GW	Well-graded gravels and gravel-sand mixtures; little or no fines.
		GP	Poorly graded gravels and gravel sand mixtures; little or no fines.
		SW	Well-graded sands and gravelly sands; little or no fines.
		SP	Poorly graded sands and gravelly sands; little or no fines
	Coarse sands and gravels with maximum particle size of 1 ½ inch, borderline clean.	GW-GC SP-SM Etc.	Sands and gravels which are borderline between clean and with fines
III	Fine sand and clayey gravels.	GM	Silty gravels, gravel-sand-silt mixtures.
		GC	Clayey gravels, gravel-sand-clay mixtures
		SM	Silty sands, sand-silt mixtures

		SC	Clayey sands, sand-clay mixtures
IV	Fine grained soils (inorganic)	ML	Inorganic silts and very fine sands, rock flour, silty or clayey fine sands, silts with slight plasticity.
		CL	Inorganic clays of low to medium plasticity, gravelly clays, sandy clays, silty clays, lean clays.
		MH	Inorganic silts, micaceous or diatomaceous fine sandy or silty soils, elastic silts.
		CH	Inorganic clays of high plasticity, fat clays.
V	Organic soils	OL	Organic silts and organic silty clays of low plasticity.
		OH	Organic clays of medium to high plasticity, organic silts.
		PT	Peat and other high organic soils.

* USCS system is limited to naturally occurring soils. Manufactured aggregates not covered.

PART 2 – PRODUCTS

2.01 BEDDING, HAUNCHING AND INITIAL BACKFILL MATERIAL

- A. Class I, Class II or Class III, utilized in accordance with restrictions described in Part 3 - Execution.

2.02 INSULATION

- A. Rigid extruded polystyrene insulation board, having a minimum compressive strength of 25 psi.
- B. Width:
1. 4-foot for mains 6-inch (nominal diameter) and larger.
 2. 2-foot for mains and service lines less than 6-inches (nominal diameter).
- C. Thickness: As stipulated on the bid schedule.

2.03 POLYETHYLENE ENCASEMENT

- D. Minimum 8 mils thickness.

PART 3 - EXECUTION

3.01 GENERAL

- A. Trenching and excavation work shall be done in accordance with proper emphasis on safety as determined by the Contractor to conform to recommended safety standards such as OSHA 1910 and 1926.

- B. Obtain all permits from appropriate road agency for construction within road right of way.
- C. Repair damage resulting from settlement, slides, cave-ins, water pressure, and other causes.
- D. Provide adequate signs, barricades, fences and amber lights and take all necessary precautions to protect the work and the safety of the public in all construction areas.
 - 1. Placement of construction signs and barricades shall conform to the "Manual on Uniform Traffic Control Devices."
 - 2. Protect barricades and obstructions at night by amber signal lights that burn from sunset to sunrise. Barricades shall also be of substantial construction, painted white or with reflective paint to increase their visibility at night.
 - 3. Perform work without obstruction to traffic or inconvenience to the general public and the residents in the vicinity of the work.
- E. Road Crossing
 - 1. Comply with all construction and material requirements of roadway authorities having jurisdiction.
 - 2. Maintain one lane of traffic open at all times.
 - 3. Refer to Section 02705 – Road Restoration for backfill and restoration requirements.

3.02 EXCAVATION

- A. Remove trees and stumps from excavation and site.
- B. Remove and stockpile existing topsoil.
- C. Install facilities as staked unless otherwise approved by Engineer.
- D. Maintain surface drainage away from trenching or excavation.
- E. Remove unsuitable foundation materials from excavation as shown on the plans or as authorized by the Engineer.
- F. Maintain a minimum 1-foot clearance between outer surface of structure being installed and wall of excavation.

- G. Rock encountered shall be classified, excavated and measured in accordance with Section 02316 – Rock Excavation

3.03 TRENCHING

- A. Bottom width: No less than 12 inches or more than 36 inches wider than the outside diameter of the pipe.
- B. Depth: Provide minimum cover as specified, or depths shown on plans.

3.04 BEDDING

- A. If existing soil cannot provide uniform, stable bearing support, over-excavate 6 inches below bottom of pipe or structure and provide bedding material.
- B. Utilize Class I, II or III materials as appropriate for bedding as listed in Table below.

Use of Soils and Aggregate for Bedding

	<i>Class IA</i>	<i>Class IB</i>	<i>Class II</i>	<i>Class III</i>
General	Excellent pipe support. Excellent drainage.	Excellent pipe support. Good drainage. Minimizes migration of adjacent material.	Good pipe support. Fair drainage.	Reasonable pipe support. Poor drainage
Compaction	Not required	Not required	Required 90% of Standard Proctor.	Required 90% of Standard Proctor.
Wet Conditions (below current or future water table). Rock Cuts	Acceptable. Must use same material for Haunching.	Acceptable. Must use same material for Haunching.	Acceptable. Clean groups only suitable for drainage blanket.	Not- Acceptable
Dry Conditions	Acceptable	Acceptable	Acceptable	Acceptable

3.05 HAUNCHING AND INITIAL BACKFILL

- A. General
 1. Provide complete and uniform bearing and support for the pipe, including allowance for bell holes, or structure.
 2. Work material under and around the pipe to ensure full pipe support.
 3. Prevent movement of the pipe during placement of material.
 4. Avoid contact between the pipe and mechanical compaction equipment.

- B. Utilize Class I, II or III materials as appropriate for haunching and initial backfill as listed in Table below. No frozen materials or frozen clods.

Use of Soils and Aggregate for Haunching and Initial Backfill

	<i>Class IA</i>	<i>Class IB</i>	<i>Class II</i>	<i>Class III</i>
General	Excellent pipe support. Excellent drainage. Install to a minimum of 6" above the pipe crown.	Excellent pipe support. Good drainage. Minimizes migration of adjacent material. Install to a minimum of 6" above the pipe crown.	Good pipe support. Fair drainage. Install and compact to a minimum of 6" above the pipe crown.	Reasonable pipe support. Poor drainage. Install and compact to a minimum of 6" above the pipe crown.
Compaction	Not required	Not required	Required 85% of Standard Proctor. 6 inch maximum lifts.	Required 90% of Standard Proctor. 6 inch maximum lifts.
Wet Conditions (below current or future water table). Rock Cuts	Acceptable. Must use same material for Bedding. Extend Haunching to the top crown of the pipe.	Acceptable. Must use same material for Bedding. Extend Haunching to the top crown of the pipe.	Acceptable. Clean groups only suitable for drainage.	Not- Acceptable
Dry Conditions	Acceptable	Acceptable	Acceptable	Acceptable

3.06 FINAL BACKFILL

- A. Backfill remainder of excavation with native material, free from large clods, large stones, organic material or frost chunks unless otherwise specified below.
- B. Backfill within roadways, driveways, and shoulders.
1. Conform to Section 02705 – Road Restoration for backfill requirements under roadways, driveways, and shoulders.
- C. Backfill around structures.
1. Backfill and compact around manholes, valve boxes, and other appurtenances in 12-inch lifts.
 - a. Compact with a mechanical tamper to a density not less than 90% of the maximum dry density, determined by ASTM D 698.
 - b. Compaction around structures in roadways, driveways, and shoulders shall conform to Section 02705.
 2. Backfill around septic tanks in 18-inch lifts.
 - a. Compact in a manner that will not produce undue strain on the tank.

- b. Compaction may be accomplished with the use of water, provided the material is thoroughly wetted from the bottom up, and the tank is filled with water to prevent floating.
- D. Backfill of trenches and other locations not listed above.
 - 1. Compact in 18-inch lifts to a density not less than the density of the surrounding undisturbed soil.
 - 2. Provide 3 feet minimum of backfill over the pipe before wheel loading the trench.
 - 3. Provide 4 feet minimum cover over the top of the pipe before utilization of hydrohammer compaction equipment.
 - 4. Compact in smaller lifts if the required compaction cannot be obtained.
 - 5. Lifts may be increased at the discretion of the Project Engineer if required compaction can be obtained.
- E. Repair any trenches improperly backfilled or where settlement occurs, then refill and compact.
- F. Restore surface to the required grade and compaction. Conform to Section 02310 – Grading for rough grading, finish grading and site surface drainage.
- G. Remove all surplus backfill materials to a location approved by the Engineer.

3.07 FROST PROTECTION

- A. Place insulation in areas where water main, sewer service lines or water service lines cross a road, driveway, traveled path, as indicated on the plans or as directed by the Engineer.
- B. Center insulation over the main with no more than 6 inches of compacted fill between the pipe and the insulation. Grade fill so insulation lays flat.
- C. Maintain a straight alignment of insulation.
- D. Extend insulation a minimum of 5 feet on each side of the crossing.
- E. Lap insulation by 6 inches or stagger by 6 inches if composed of two layers.
- F. Minimum thickness for the first lift of backfill over the insulation is 8 inches.

1. Do not operate construction equipment directly on insulation. Do not compact first lift with backhoe-mounted compactor, or any other large compaction equipment.
2. Compact remaining backfill using normal construction practices.

3.08 POLYETHYLENE ENCASEMENT

- A. All metallic mainline pipe, fittings, and appurtenances installed in aggressive soils shall be wrapped with polyethylene in accordance with ANSI/AWWA C105/A21.5.
- B. The wrap shall extend 2-feet beyond all metallic fittings/appurtenances and cover the entire length of metallic pipe. All rips or punctures shall be repaired with tape or by rewrapping that area with polyethylene film.
- C. After assembling the pipe joint, the polyethylene shall be overlapped approximately 1-foot and at all joints sealed with approved adhesive tape. Additional taping shall be used at 3-foot intervals along the pipe. All copper service connections shall be wrapped for a distance of 3-feet from the center line of the main. Before installing the polyethylene wrap, the exterior of the pipe shall be free of foreign material.

3.09 REMOVAL OF NUISANCE WATER

- A. Remove nuisance water entering the trenches. Nuisance water that can be removed through the use of sump or trash pumps is not considered dewatering.
- B. Keep trenches free from water until the facilities are in place, sealed against the entrance of water, and backfill has been placed and compacted above the water level.

3.10 LOCATE EXISTING UTILITIES

- A. Field locate all existing underground utilities.
 1. Utilize state “dig-safe” or “one-call” hotlines.
 2. Contact all other utility owners not covered by the state “dig safe” hotlines.

3.11 UTILITY CONFLICTS

- A. Protect existing utilities from damage during excavation and backfilling operations.

- B. Provide temporary support for existing water, gas, telephone, power, or other utility services that cross the trench until backfilling of trench is complete
 - 1. Compact backfill to 95% of Standard Proctor Density under disturbed utilities.
 - 2. Repair or replace any damaged existing utilities, at no additional cost to the project.

- C. Water and sewer main crossing and parallel installation
 - 1. Maintain a 10 foot horizontal separation (O.D. to O.D.) for parallel mains.
 - 2. Upon approval by the Engineer, water and sewer mains may be installed closer than 10 feet, provided all of the following conditions;
 - a. Vertical separation is 18 inches (O.D. to O.D.)
 - b. Water main is above the sewer main.
 - c. Separate trenches are maintained.
 - 3. Maintain a minimum 18-inch vertical separation (O.D. to O.D.) for crossing mains.
 - a. Lay pipe with joints equidistant from the point of crossing.
 - 4. If it is impossible to meet any of the above separation distances and deviations, one of the following methods shall be adhered to.
 - a. Sewer main shall be constructed to water main pressure pipe standards, and successfully pass a 150-psi pressure test prior to backfilling.
 - b. Either the water main or the sewer main may be encased in a watertight carrier pipe that extends 10 feet on both sides of the crossing. The carrier pipe shall be of materials approved by the regulatory agency for use in water main construction.

- D. Water and sewer service crossing and parallel installation.
 - 1. Maintain a 30-inch horizontal separation from water and sewer services.
 - 2. Maintain a 12-inch vertical separation for crossing water and sewer services.
 - 3. Water service line splices or joints will not be permitted within 10 feet of a sewer line crossing.

3.12 MOVING FENCES AND MINOR STRUCTURES

- A. Remove and reset culverts, drainage pipes or other minor structures that fall within the alignment of the new construction, to their original location and grade.
- B. Visit the project site and determine actual conditions with regard to the existence of old car bodies, abandoned houses, fences, driveways, trees, stumps, brush, sidewalks, approaches, and other miscellaneous obstacles to construction.
 - 1. Unless specifically referenced in a bid item, no separate payment will be made for the removal or replacement of these items.

3.13 RECORDS

- A. Conform to as-built requirements in Section 01780 – Closeout Submittals.

END OF SECTION

**SECTION 02370
TEMPORARY EROSION AND SEDIMENT CONTROL**

PART 1 - GENERAL

1.01 SUMMARY

- A. This section includes temporary erosion and siltation control measures accomplished through the use of silt fences, hay bales, erosion mats and other erosion control devices or methods.

1.02 RELATED WORK (as applicable)

- A. Section 02310 – Grading
- B. Section 02315 – Excavation, Trenching and Backfill
- C. Section 02920 – Topsoiling, Seeding, Fertilizing and Mulching

1.03 REFERENCES

- A. Minnesota Pollution Control Agency – Best Management Practices Handbook
- B. Environmental Protection Agency - 1987 Congressional Amendments, Clean Water Act, Section 402.

1.04 SUBMITTALS

- A. Method of Erosion Control
- B. Silt Fence and Appurtenances
- C. Erosion Mats and Appurtenances
- D. Erosion Control Plan (If requested by the Engineer)

1.05 QUALITY ASSURANCE

- A. Erosion control materials, methods and practices shall conform to the applicable state agency handbooks of Best Management Practices, or tribal laws established for the purpose of erosion control on construction sites.
- B. Obtain and pay for permits and inspections in accordance with the provisions of all local government agencies having jurisdiction. No additional claim for compensation will be allowed because of the Contractor's failure to obtain or pay for such permits and inspections.

PART 2 - PRODUCTS

2.01 SILT FENCING

- A. Applicability

1. Heavy Duty: General use during site grading to protect critical areas and bodies of water.
2. Standard: Light-duty applications to protect temporary construction or to supplement the other types of silt fence.
3. Machine-slice: For most applications.

B. Geotextile properties:

Description	Heavy Duty	Standard	Machine Slice
Type	Woven	Woven	Monofilament
Width	48 inches	36 inches	36 inches
Grab Tensile Strength (ASTM D 4632)	100 lb Min	100 lb Min	130 lb Min
Apparent Opening Size (ASTM D 4751)	20-70 Sieve	20-70 Sieve	30-40 Sieve
UV Stability (ASTM D 4355 500 hr)	70% Min	70% Min	70% Min
Top-fastening Component	Overlap around woven wire backing	Sewn-In cord	

* From Minnesota BMP

C. Net Backing

Description	Heavy Duty	Standard	Machine Slice
Material	Woven wire	N/A	N/A
Min. Weight	14-1/2 gauge		
Min. Mesh Opening	2 inches		
Max Mesh Opening	6 inches		
Min. Width	30 inches		
Tensile Strength (ASTM D 4595)	100 lb/ft		
UV Stability (ASTM D 4355 500 hr)	70% Min		

* From Minnesota BMP

D. Post properties:

Description	Heavy Duty	Standard	Machine Slice
Material	Metal	Wood	Metal
Min. Size	1.25 lb/ft	1.5 inch x 1.5 inch	1.25 lb/ft
Min. Length	5 feet	4 feet	5 feet
Min. Embedment	2 feet	1.5 feet	2 feet
Max. Spacing	8 feet	8 feet	6 feet
Type of Post Fasteners	U-shaped clips. No. 16 gauge wire	Gun staples 0.5 inch long	Plastic zip ties (50lb tensile strength)
Min. Fasteners per Post	3	5	3

* From Minnesota BMP

E. All seams shall be heat sealed or sewn

2.02 EROSION BALES

A. Applicability: Can be used in locations where silt fencing is used.

- B. Rectangular clean hay bales or straw bale.
- C. Posts: Wood or steel, 2" x 2" x 54" minimum.

2.03 EROSION CONTROL MATS

- A. Biodegradable or photodegradable erosion control mat equal to American Excelsior Curlex II with a minimum 4-foot mat width.

2.04 OTHER

- A. Other materials proposed by the Contractor shall conform to standards published by the applicable state agency handbooks of Best Management Practices (BMP's).

PART 3 – EXECUTION

3.01 GENERAL

- A. Coordinate temporary and permanent erosion control measures to assure economical, effective and continuous erosion control.
- B. Keep construction areas small.
- C. Divert drainage away from construction areas.
- D. Perform construction in and adjacent to rivers, streams, lakes or other waterways in such a manner as to avoid washing, sloughing or deposition of material into waterways which will result in undue or avoidable contamination, pollution or siltation of such waterways.
- E. Inspect and maintain erosion control materials to ensure its continued effectiveness.
 - 1. Remove sediment material captured by erosion control systems before systems fails.
 - 2. Inspect and repair erosion control systems within 48 hours of rain event.
- F. Remove erosion control only after the area has stabilized and vegetation has developed to the extent that further erosion is unlikely.
- G. Submit a plan for erosion control measures that are in compliance with State BMPs and/or Federal EPA requirements, if the area to be disturbed is greater than one (1) acre total.

3.02 TEMPORARY EROSION CONTROL

A. Use temporary erosion control measures to protect ditches and drainage ways as shown on the detailed drawings and as directed by the Engineer.

B. Silt fencing (in lieu of or in combination with erosion bales)

1. Install silt fence in accordance with manufacturer's recommendations.
2. Construct the silt fence as shown on the plans and/or install on the contour of the slope.
3. Place silt fences in an arc or horseshoe shape with the ends pointing up towards the slope.
4. Maximum drainage area = $\frac{1}{4}$ acre per 100 feet of fence
5. Installation limitations:

Slope Steepness	Maximum Slope Length
2:1 (50%)	15 feet
3:1 (33%)	15 feet
4:1 (25%)	15 feet
5:1 (20%)	25 feet
10:1 (10%)	50 feet
20:1 (5%)	75 feet

6. Compact the soil immediately next to the silt fence fabric.
7. Clean silt fence when sediment reaches $\frac{1}{3}$ height of the silt fence.

C. Erosion Bales

1. Install hay bales as shown on the plans and/or install on the contour of the slope.
2. Installation limitations:

Slope Steepness	Maximum Slope Length
2:1 (50%)	15 feet
3:1 (33%)	15 feet
4:1 (25%)	15 feet
5:1 (20%)	25 feet
10:1 (10%)	50 feet
20:1 (5%)	75 feet

3. Install hay bales in 4-inch deep trench.

4. Place bales at right angles to the direction of flow.
5. Securely anchor each bale with stakes as shown on the plans.
6. Compact soil on the upslope side of the hay bales.
7. Fill gaps between bales with straw.
8. Clean sediment away from bale when sediment reaches 1/2 height of the hay bale.
9. Replace damaged, destroyed or rotted bales immediately.
10. Bales may be used for mulching material if they meet the specifications of Section 02920.

D. Erosion Control Mats

1. Where indicated on the plans, by the Project Engineer, or on slopes greater than 5%, use a wood fiber mat in lieu of mulch.
2. Install in accordance with manufacturer's recommendations
3. Roll matting strips in the direction of the flow.
4. Spread mat evenly, smoothly, and in a natural position without stretching and with all parts touching the soil.

END OF SECTION



This Page Intentionally Left Blank

**SECTION 02512
INDIVIDUAL HOUSEHOLD WATER SYSTEMS**

PART 1 - GENERAL

1.01 SUMMARY

- A. This section includes the installation of submersible pumps, drop pipe, electrical cable and controls, pressure tanks, service lines, and pitless units from the well to the household.

1.02 RELATED WORK (as applicable)

- A. Section 02315 – Excavation, Trenching and Backfill
- B. Section 02525 – Individual Well Drilling

1.03 REFERENCES

- A. ASTM A 53 – Pipe, Steel, Black and Hot-Dipped, Zinc-Coated Welded and Seamless
- B. ASTM D 1785 – Polyvinyl Chloride (PVC) Plastic Pipe, Schedules 40, 80, and 120
- C. AWWA C901 – Polyethylene (PE) Pressure Pipe and Tubing, 1/2 Inch Through 3 Inch, for Water Service
- D. National Electric Code (NEC)

1.04 SUBMITTALS

- A. Heavy Duty Brass Check Valve
- B. Submersible Cable
- C. Submersible Pumps
- D. Drop Pipe
- E. Buried Cable
- F. Water Service Line and Fittings
- G. Pressure Tank and Switches
- H. Freezeless Risers
- I. Lightning Arrestor (if not built into motor)
- J. Tubing/Pipe and Fittings
- K. Heat Tape and Pipe Insulation
- L. Flow Control Valve
- M. Pitless Adapter and Well Cap
- N. CLOSEOUT SUBMITTAL – Copy of Drinking Water Notice provided to each individual served

PART 2 - PRODUCTS

2.01 SUBMERSIBLE PUMPS

- A. Submersible pumps shall be sealed and constructed of all corrosion resistant materials including all exposed parts of both the pump and motor.
 - 1. Impellers and diffusers shall be constructed of bronze, stainless steel or plastic.
 - 2. Pump shaft shall be hexagonal or splined stainless steel and connected to the motor shaft with a splined coupling.
 - 3. Pump casing shall be bronze, brass or stainless steel.
 - 4. Motor adapter and pump discharge head shall be bronze, brass or other corrosion resistant material.
 - 5. Motor casing and end caps shall be stainless steel, brass, bronze or other corrosion resistant material.

- B. Pump Requirements:
 - 1. Pump Design for 3 Wire Installation unless specified otherwise in Section 01119
 - 2. High Torque Motor
 - 3. 230 Volt Operation
 - 4. Overload Protection
 - 5. Solid State Starting Switch
 - 6. NEMA Standard for Universal Motor Replacement
 - 7. 1/3 horsepower pumps shall have a pumping capacity of 8 gpm against a total head of 150 feet.
 - 8. 1/2 horsepower pumps shall have a pumping capacity of 8 gpm against a total head of 200 feet.
 - 9. 3/4 horsepower pumps shall have a pumping capacity of 8 gpm against a total head of 280 feet.
 - 10. 1 horsepower pumps shall have a pumping capacity of 8 gpm against a total head of 360 feet
 - 11. A check valve shall be installed in the pump.

- C. Size the pump to be installed based on test pump data and well log.

- D. Lightning protection shall be built into the pump motor or a submittal for the arrestor and installation method shall be provided.

2.02 SUBMERSIBLE PUMP CABLE

- A. Use RHW insulated and jacketed, U.L. approved, rated at 600 volts, manufactured in accordance with the NEC and be a minimum size of No. 12.
 - 1. Submersible pump cable shall be Essex CPE, MilSpec Milpreme double insulated or approved equal.
 - 2. THW insulated and jacketed pump cable meeting the above requirements such as Centrline HILO Supreme or approved equal may be substituted for the RHW standard.
- B. Allowable voltage drop through the cable, from the electrical service to the pump motor, shall be in accordance with pump manufacturer's recommendation.
- C. Waterproof splice shall be in accordance with pump manufacturer's recommendation.

2.03 DROP PIPE AND FITTINGS

- A. Steel Drop Pipe
 - 1. Conform to ASTM A 53
 - 2. Pipe shall be Schedule 40 galvanized steel with a nominal size of 1-inch.
 - 3. Galvanized steel couplings shall be used to connect pipe sections.
- B. PVC Drop Pipe
 - 1. Conform to ASTM D 1785
 - 2. Pipe shall be threaded Schedule 80 with a nominal size of 1-inch.
 - 3. Couplings shall be machined from extruded, not molded, PVC.
- C. PE Drop Pipe
 - 1. Conform to AWWA C901
 - 2. Pipe shall be ultra-high molecular weight, IDR 7, 1-inch IPS with a minimum pressure rating of 160 psi.
 - 3. Torque arrestor shall be equal to Merrill No. STA-48.

- 4. Cable protector centering device shall be equal to Merrill No. CG-46.
- D. Check valves shall be equal to Clayton Mark No. 6300.
- E. Flow control valves shall be equal to a Merrill Dole Valve, G series flow regulator.

2.04 WATER SERVICE LINE

- A. Conform to AWWA C901.
- B. Ultra-high molecular weight, PE 3406, 3408, 3608, or 4710, IDR of 7 or 9 with a minimum pressure rating of 160 psi, and suitable for use with potable water.

2.05 PIPING AND FITTINGS

- A. Copper tubing: $\frac{3}{4}$ inch seamless, thick-wall type L with a minimum wall thickness of 0.045 inches.
 - 1. Only copper tubing is allowed for installations under mobile homes and other homes without a basement where piping is located in an unheated space.
- B. PEX tubing: $\frac{3}{4}$ inch cross linked polyethylene tubing, ASTM F876 and F877, and approved for use with potable water.
- C. Copper tubing fittings: Compression type connections or adapter with union used for copper pipe equal to those manufactured by Hays Manufacturing Company, A.Y. McDonald, Mueller Company or Ford Meter Company.
- D. PEX tubing fittings: Crimp fittings specifically manufactured for use on PEX tubing.
- E. No galvanized fittings are allowed.

2.06 HEAT TAPE AND PIPE INSULATION

- A. Heat tape: Non-thermostatically controlled heat tape with stainless steel braiding equal to Easyheat Freeze or Frotex Wintergard.
- B. Pipe insulation: Preformed foam pipe insulation. Thickness shall be in accordance with manufacturer's recommendation.

2.07 PIPE HANGERS

- A. Shall be made of a material compatible with piping material.

- B. Shall be of sufficient strength to support the pipe at full capacity.
- C. Shall not affect pipe integrity by either abrading, cutting or bending of pipe.

2.08 PRESSURE TANK

- A. Supply pressure tanks precharged in accordance with the manufacturers recommendations, for a 30 to 50 psi operating range, having a sealed container or diaphragm that prevents contact of water with air.
- B. Tanks shall be lined with a noncorrosive material that does not impart taste or odor to the water and provide a minimum of 8.9 useable gallons of draw down.
- C. Tanks shall be equal to Well-X-Trol Model WX-203 or Champion Model CM-8003.
- D. Pressure switches shall be equal to Square D Model FSG2.

2.09 PLUMBING TREE

- A. The plumbing tree in front of the pressure tank includes the following:
 - 1. ¼ turn brass lever ball valve
 - 2. Metal sample faucet with smooth bore hole or a hose bib with vacuum breaker. Minimum diameter ¼ inch.
 - 3. Pressure switch
 - 4. Pressure gauge
 - 5. Dielectric union

2.10 BURIED CABLE

- A. Underground wiring shall be type UF for direct burial with a minimum size of No. 12.
- B. Size underground wiring to limit the total voltage drop from the electrical service to the pump motor in accordance with manufacturer's recommendations.

2.11 FREEZELESS RISERS

- A. No galvanized fittings are allowed when connecting the freezeless riser.
- B. Risers must be provided with a swing joint and be equal to True-Temp Positive Purge Model 7PPDB with copper riser pipe or Thermaline model 15.

- C. Freezeless riser manufacturer shall supply the thermostatically controlled heat tape unless riser shut off valve is installed above floor grade.
- D. Use compression type or an adapter with union connections for copper pipe.
 - 1. Acceptable manufacturers are Hays Manufacturing Company, A.Y. McDonald, Mueller Company or Ford Meter.

2.12 PITLESS ADAPTER AND CAP

- A. Steel Cased Wells: Weld-on type, equal to Maass Model J, with 1-inch size water outlet.
- B. PVC Cased Wells: Equal to Safe-T-Seal, with a 1-inch water outlet.
- C. Cap
 - 1. Vented, weather and vermin proof cap with gasket. All nuts and bolts shall be made of non-corrodible material.
 - 2. Screened downward facing vent not less than ¼-inch in diameter.
 - a. Screen shall be made of non-corrodible material.

PART 3 - EXECUTION

3.01 GENERAL

- A. Obtain Engineer's approval to install water system if well yields less than 5 gpm.
- B. Install water system in accordance with state and local codes.

3.02 PITLESS ADAPTER

- A. Steel Cased Wells
 - 1. Weld onto casing 8 feet below grade.
 - 2. Seal with neoprene o-ring.
 - 3. Conform to state and local codes.
- B. PVC Cased Wells
 - 1. Install onto casing 8 feet below grade.

2. Connection shall be watertight.

3.03 WELL CAP

- A. Install well cap tightly to top of well casing to provide sanitary seal.
- B. Seal any unscreened openings until conduits are connected.

3.04 PUMP AND DROP PIPE

- A. Install pump a minimum of 5 feet to a maximum of 20 feet below the drawdown level measured from the top of pump unless otherwise directed by the Engineer.
- B. Do not install pump in well screen unless otherwise directed by the Engineer.
- C. Set and install drop pipe and submersible pump in accordance with state and local codes.
 1. If a change in pump size is required, the Contractor and contracting officer shall negotiate a new pump price.
- D. Install a check valve midway between the pump and pitless adapter in drop pipe greater than 200 feet.
- E. Use tape or approved joint compound on all threaded connections.
- F. The depth limitation for using Schedule 80 PVC is 400 feet.
- G. PE Pipe
 1. Install PE pipe in one single length (no couplings) from the pitless unit to the submersible pump.
 2. Install an approved torque arrestor at the pump.
 3. Install cable protector devices every 50 feet above the pump to center the PE pipe in the casing.
 4. The depth limitation for PE pipe is 300 feet and the maximum pump size is 1 horsepower.
- H. If required by the Engineer, install flow control valve between the pitless spool and the drop pipe unless specified otherwise in Section 01119.

3.05 SUBMERSIBLE CABLE

- A. Securely attach submersible pump cable to the drop pipe every 10 feet, using tape or other method approved by the Engineer.
- B. Provide an extra 12 inches of cable under the well cap.
- C. The only splice allowed in the pump cable will be at the motor and the splices shall be made using taped, mechanical or resin splices.
- D. Test cables for leakage or shorts using an ohmmeter or megger.

3.06 TRENCH EXCAVATION AND BACKFILLING

- A. Refer to Section 02315 for excavation and backfilling requirements.

3.07 WATER SERVICE LINE

- A. Bury water service lines 8 feet deep unless otherwise noted in section 01119.
- B. Connect water service line to the pitless adapter with a brass or bronze swing joint connection as shown on the plans.
- C. If the water from the house has been installed, connect the water line to the stubbed out line from the house, otherwise extend into the house and connect into the plumbing for the hydropneumatic tank.
 - 1. Provide a watertight seal on the penetration through the wall.
 - 2. For connecting beneath the home, install pipe hangers at a maximum spacing of 6 feet apart for all horizontal copper tubing and 2 feet apart for all horizontal PE pipe inside the home.
- D. Make connections with brass insert adapters and two stainless steel hose clamps or non-flare brass compression fittings.
- E. Where designated by the Engineer, terminate the water service line 5 feet from the house and cap.
 - 1. Mark the end with a 2 by 4-inch stake painted blue extending 1-foot above grade and 4 feet below grade.

3.08 UNDERGROUND UTILITY CONFLICTS

- A. Refer to Section 02315.

3.09 BURIED CABLE

- A. Install underground cable in accordance with local utility regulations, the NEC, applicable state and local codes and the attached drawings.
- B. No underground splices are allowed.
- C. Control power to each unit with a fused disconnect switch or manually reset circuit breakers placed in the home, where possible, or otherwise on a power pole near the well.
- D. Provide disconnecting means located in site of controller location.
- E. Connect underground wiring to the pump cable under the well cap. Provide an extra 12 inches of slack cable under the well cap.
- F. Securely attach the ground wire to the casing with a threaded metal screw tapped into or drilled through the casing.
- G. Ground the submersible pump and well casing to the panel in accordance with the NEC.
- H. Install wiring in a rigid galvanized steel or Schedule 80 PVC conduit at the electrical entrance and the wellhead to 2 feet below ground.
 - 1. Conduit end shall be smooth and free of sharp edges
 - 2. Snuggly fit the conduit end into the well cap. Maintain sanitary seal.
 - 3. Bushings are required as shown on the detailed drawing.
- I. Provide sufficient slack in the wire to prevent separation of the cable.
- J. Underground wire may be placed in the same trench and located at the same depth as the water service line.
- K. For mobile homes and houses without basements, install underground wire in rigid conduit when placed below the structure.

3.10 FREEZELESS RISER

- A. Install freezeless risers below each mobile home and other homes where required at the locations established by the Engineer.
- B. Install directly below the point of connection to the house plumbing, whenever possible.

- C. Set risers vertical except for mobile homes.
 - 1. Set mobile home risers at an angle that will allow for the removal of the interior components of the riser without moving the mobile home or excavating the freezeless riser.
- D. For homes requiring freezeless risers install copper tubing from the riser to the house plumbing.
 - 1. Install pipe hangers at a maximum spacing of 6 feet apart for all horizontal copper tubing inside the home.
- E. At 90 degree bends install elbows or make long radius bends.
- F. No kinks in the copper tubing will be permitted.
- G. Make solder joints with lead free solder.
- H. Risers with shut off valves installed above floor grade shall be equipped with non-thermostatically controlled heat tape.

3.11 CONNECTION OF WATER SERVICE LINE TO HOME

- A. Install only copper tubing for installations under mobile homes and other homes without a basement where piping is located in an unheated space.
 - 1. Install copper tubing/pipe from freezeless riser to connection to the home.
 - 2. Utilize fittings to change direction of piping or make long radius bends. Kinks in the copper tubing are not allowed.
 - 3. Solder joints with lead free solder.
 - 4. Heat tape shall be installed along the copper tubing/pipe from the end of the freezeless riser in accordance with the manufacturer's recommendations.
 - 5. Preformed foam pipe insulation shall be installed from the end of the freezeless riser to the connection to the home in accordance with the manufacturer's recommendations.
 - a. Heat tape and copper tubing/pipe shall be wrapped completely with the performed foam pipe insulation.

6. Contractor shall verify there is adequate wraps of heat tape around the copper tubing/pipe and that the supplied preformed pipe insulation is of adequate thickness to prevent freezing of the copper tubing/pipe.
7. Plug heat tape into dedicated outlet underneath the home. If there is no outlet, the homeowner is responsible for installation of an outlet for the heat tape. Extension cords are not allowed. Contractor shall notify the engineer and homeowner if there is not an electrical outlet to plug in the heat tape.
8. Connection of the water service line to the home within a heated space shall be done with similar pipe material as the house plumbing with either copper or PEX tubing as specified.

3.12 BACTERIOLOGICAL SAMPLE/DRINKING WATER NOTICE

- A. Provide bacteriological sample for water system after system has been installed and flushed.
- B. Contractor shall inform the homeowner(s) not to consume any water until a safe bacteriological and chemical analysis result has been received by using the "Drinking Water Notice" form attached to this specification.
- C. Provide a copy of the "Drinking Water Notice" to the Engineer. No payment will be made for water system until the bacteriological sample result and "Drinking Water Notice" has been received.

3.13 PRESSURE TANK AND FITTINGS

- A. Place tanks inside home as located by the Engineer and the homeowner.
- B. Install tanks as shown on the attached drawings, including pressure gauge, pressure switch, brass tank cross, sample faucet, ball valve and all miscellaneous fittings and adapters.
 1. Install sample faucet a minimum of 12-inches above finished floor elevation.
- C. Use leveling blocks or hangers when installing tanks.
- D. Connect tank to existing plumbing if available.
- E. Install tank so that it can be connected to house plumbing.
- F. For tanks with a steel inlet fitting use a dielectric union, installed between the inlet pipe and the brass cross.

G. Install tank and cross such that the tank can be easily removed.

H. Install pressure relief valve if required.

3.12 AS-BUILTS

A. Provide as-built information on each system in accordance with Section 01780 and Section 02525. Use IHS forms (if supplied) by the Engineer.

B. Provide Engineer with the pump setting depth.

END OF SECTION

DRINKING WATER NOTICE FOR _____

IMPORTANT INFORMATION ABOUT YOUR DRINKING WATER

SERVICES PROVIDED

You have been provided new water facilities from the Indian Health Service. Your home has been serviced to provide a source of clean water for you and your household. As part of the Indian Health Service's goal, we want to assure that these personal health services are safe to meet the needs of your daily use. The following important sections discuss your water quality and the steps we are taking to meet this goal.

YOUR WATER IS BEING TESTED FOR:

Safe Bacteriological Analysis

The laboratory report will indicate the presence or absence of coliform bacteria and E. Coli.

Chemical Analysis

Your water is also being tested for hardness, iron, manganese, nitrate and arsenic. The laboratory report will show the levels of each of these five (5) parameters. Results for the chemical analysis are typically obtained in approximately 30 days from when the laboratory receives the samples.

CAN I DRINK/CONSUME MY WATER RIGHT NOW?

It is not recommended to drink/consume the water until it has been tested! There is potential your water can contain one or more harmful substances that may affect your health. It is strongly advised to wait until you receive the results of your water testing to confirm these substances are either not present or are within acceptable levels before it is consumed. The possible health concerns relate to the presence of potentially harmful bacteria as well as high levels of nitrates and/or arsenic. The presence of certain bacteria in drinking water may indicate the presence of harmful, disease-causing organisms that can cause serious illness. High levels of nitrates and/or arsenic can affect humans at any age. Women who are pregnant, young children and senior adults are the most vulnerable.

Note: The water can still be used for cleaning and washing purposes prior to receiving the test results.

WHEN/HOW WILL I FIND OUT IF I CAN DRINK MY WATER?

You will be contacted by the Tribal contact listed below within approximately 30 days who will let you know if your water is safe to consume. If your test results come back showing any concerns, your water will be re-tested and appropriate actions will be taken to ensure that your water is safe for consumption before service to your site is complete.

Once service to your site is complete, you will receive a homeowner packet from the Indian Health Service. In this homeowner packet will be documents regarding the services you received as well as copies of the laboratory test results of your drinking water. The test results will be summarized and show you the quality of your drinking water.

Questions regarding this notice can be directed to:

Name of Tribal Contact: _____

Phone number: _____

Installed by: _____
(Name of Company)

Phone No.: _____

Date: _____

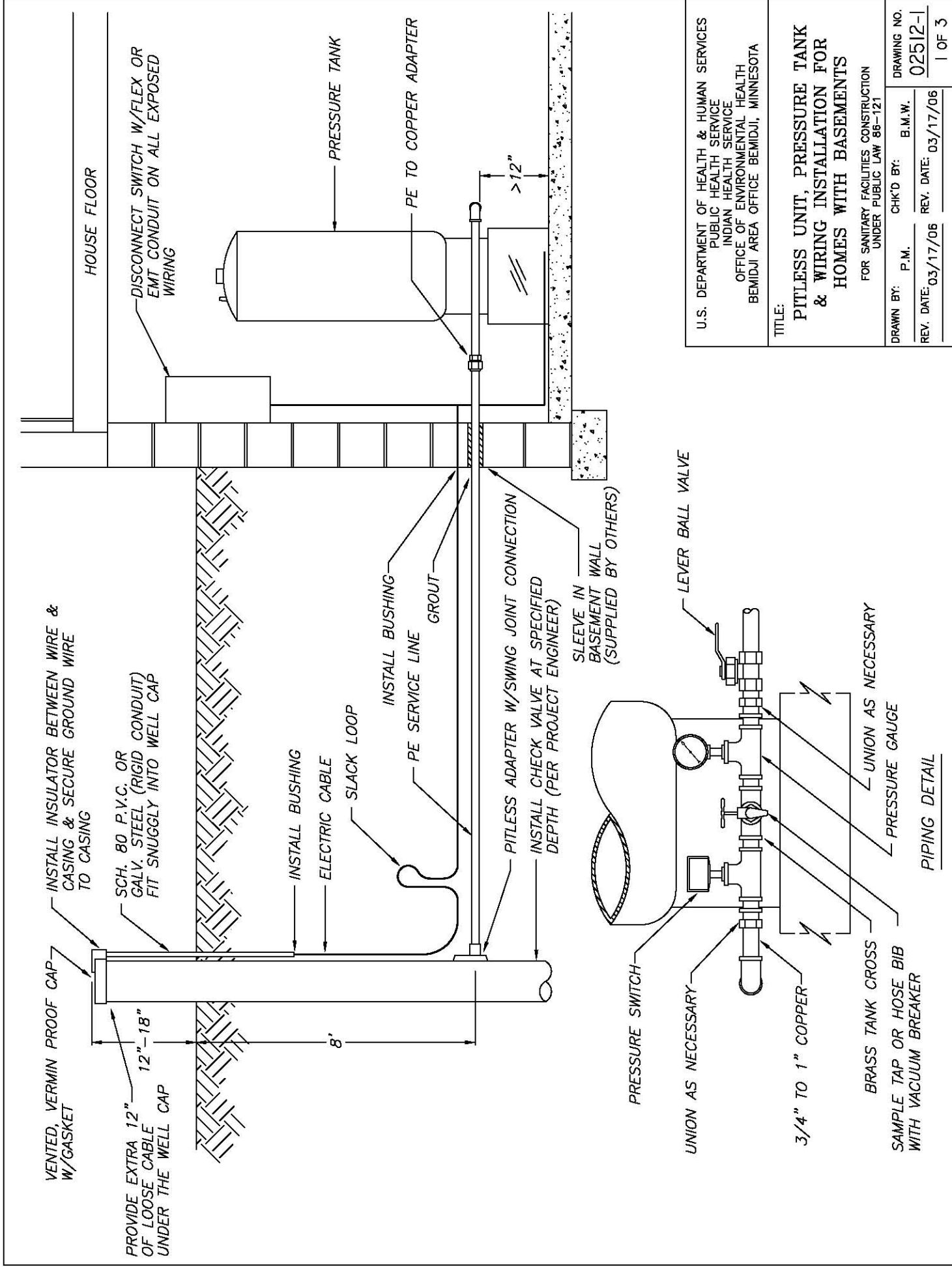

U.S. DEPARTMENT OF HEALTH & HUMAN SERVICES
 PUBLIC HEALTH SERVICE
 INDIAN HEALTH SERVICE
 OFFICE OF ENVIRONMENTAL HEALTH
 BEMIDJI AREA OFFICE BEMIDJI, MINNESOTA

TITLE:
**PITLESS UNIT, PRESSURE TANK
 & WIRING INSTALLATION FOR
 HOMES WITH BASEMENTS**
 FOR SANITARY FACILITIES CONSTRUCTION
 UNDER PUBLIC LAW 86-121

DRAWN BY: P.M. CHK'D BY: B.M.W. DRAWING NO. 02512-1
 REV. DATE: 03/17/06 REV. DATE: 03/17/06 I OF 3

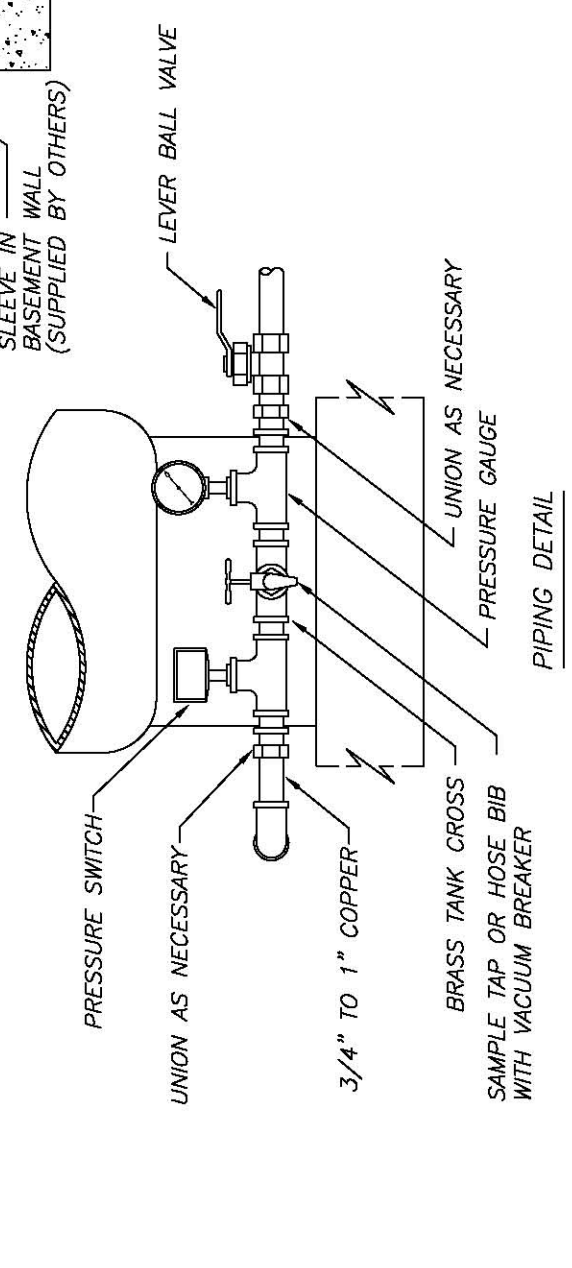

PIPING DETAIL

NOTE:

ALL HOLES DRILLED IN FLOOR SHOULD BE SEALED BY APPROVED METHOD

SCH. 80 P.V.C. OR GALV. STEEL (RIGID CONDUIT) FITTED SNUGLY INTO WELL CAP

INSTALL INSULATOR BETWEEN WIRE & CASING AND SECURE GROUND WIRE TO CASING

VENTED, VERMIN PROOF CAP WITH GASKET

PROVIDE EXTRA 12" OF LOOSE CABLE UNDER THE WELL CAP

24"
INSTALL BUSHING
ELECTRIC CABLE
SLACK LOOP

8'

PITLESS ADAPTER W/SWING JOINT CONNECTION
INSTALL CHECK VALVE IF REQUIRED (PER PROJECT ENG.)

DISCONNECT SWITCH W/FLEX OR EMT CONDUIT ON ALL EXPOSED WIRING

PRESSURE TANK

PRESSURE SWITCH

UNION AS NECESSARY

3/4" TO 1" COPPER

MOBILE HOME FLOOR

UNION AS PER SPECS.

FREEZELESS RISER SLANTED PER SPECS.

PE SERVICE LINE

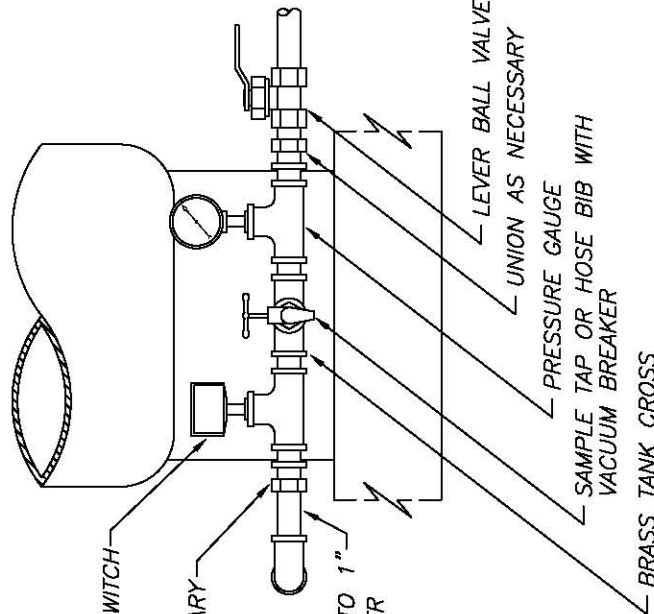

PIPING DETAIL

U.S. DEPARTMENT OF HEALTH & HUMAN SERVICES
PUBLIC HEALTH SERVICE
INDIAN HEALTH SERVICE
OFFICE OF ENVIRONMENTAL HEALTH
BEMIDJI AREA OFFICE BEMIDJI, MINNESOTA

TITLE:
PITLESS UNIT, PRESSURE TANK & WIRING INSTALLATION FOR HOMES WITHOUT BASEMENTS OR MOBILE HOMES
FOR SANITARY FACILITIES CONSTRUCTION UNDER PUBLIC LAW '86-121

DRAWN BY: P.M.	CHK'D BY: B.M.W.	DRAWING NO. 02512-2
REV. DATE: 03/17/06	REV. DATE: 03/17/06	2 OF 3

NOTE:

ALL HOLES DRILLED IN FLOOR SHOULD BE SEALED BY APPROVED METHOD

SCH. 80 P.V.C. OR GALV. STEEL (RIGID CONDUIT) FITTED SNUGLY INTO WELL CAP

INSTALL INSULATOR BETWEEN WIRE & CASING AND SECURE GROUND WIRE TO CASING

VENTED, VERMIN PROOF CAP WITH GASKET

PROVIDE EXTRA 12" OF LOOSE CABLE UNDER THE WELL CAP

HEAT TAPE
BATT INSULATION

MOBILE HOME FLOOR
HEAT TAPE & PLUG TO OUTLET

UNION AS NECESSARY
PRESSURE SWITCH
PRESSURE TANK

DISCONNECT SWITCH W/FLEX OR EMT CONDUIT ON ALL EXPOSED WIRING

PRESSURE TANK

PRESSURE SWITCH

UNION AS NECESSARY

>12"

MOBILE HOME FLOOR

HEAT TAPE & PLUG TO OUTLET

2"-4" ABOVE GRADE

6"

5'

4" P.V.C. RISER PIPE

FOAM PIPE INSULATION

WATER SERVICE LINE

24"

INSTALL BUSHING

ELECTRIC CABLE

SLACK LOOP

8'

PITLESS ADAPTER W/SWING JOINT CONNECTION

INSTALL CHECK VALVE IF REQUIRED (PER PROJECT ENG.)

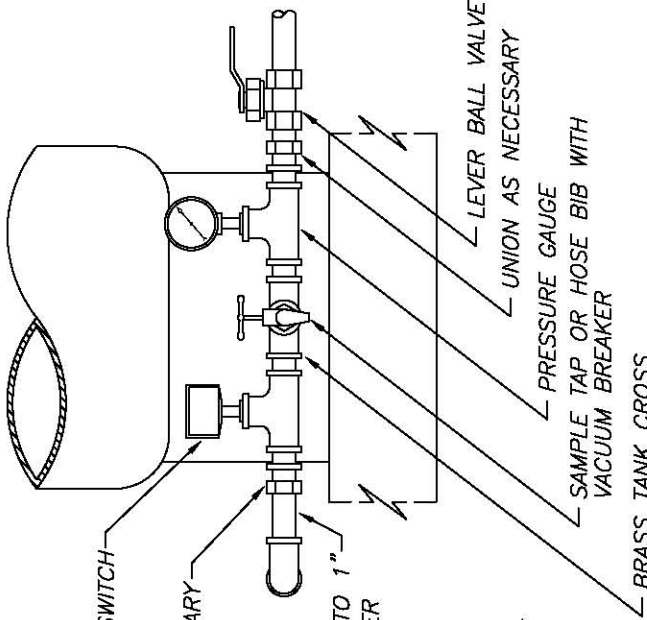

PIPING DETAIL

U.S. DEPARTMENT OF HEALTH & HUMAN SERVICES
PUBLIC HEALTH SERVICE
INDIAN HEALTH SERVICE
OFFICE OF ENVIRONMENTAL HEALTH
BEMIDJI AREA OFFICE BEMIDJI, MINNESOTA

TITLE:
PITLESS UNIT, PRESSURE TANK & WIRING INSTALLATION FOR HOMES WITHOUT BASEMENTS OR MOBILE HOMES
FOR SANITARY FACILITIES CONSTRUCTION
UNDER PUBLIC LAW '86-121

DRAWN BY: P.M.	CHK'D BY: B.M.W.	DRAWING NO. 02512-3
REV. DATE: 03/31/10	REV. DATE: 03/31/10	3 OF 3



This Page Intentionally Left Blank

SECTION 02525 INDIVIDUAL WELL DRILLING

PART 1 - GENERAL

1.01 SUMMARY

- A. This section includes drilling, casing, screening, developing and testing of water wells for individual residences.

1.02 RELATED WORK (as applicable)

- A. Section 02512 – Individual Household Water Systems
- B. Section 02528 – Well Abandonment

1.03 REFERENCES

- A. ASTM A53 – Standard Specification for Pipe, Steel, Black and Hot Dipped, Zinc Coated Welded and Seamless.
- B. ASTM F480 – Thermoplastic Well Casing Pipe and Couplings Made in SDR, Schedule 40 and 80
- C. ASTM A276 – Stainless steel well screen
- D. State of Minnesota – Department of Public Health, - Wells, Borings and Underground Uses, Chapter 4725.

1.04 SUBMITTALS

- A. Type of drilling equipment
- B. Well drilling rig operator experience and license number
- C. Drilling mud and plan for use
- D. Well screen and method of installation
- E. Gravel, sand pack material and method of installation
- F. Well casing and cap
- G. Method of disinfection
- H. Method of development

- I. Grout and method of installation
- J. Water testing lab
- K. Plan and method for hydrofracturing (if requested by the Engineer)

1.05 CONFLICTS WITH STATE WELL CODES

- A. The materials and construction methods specified herein are minimum requirements. Where the appropriate state well codes require more stringent materials or execution methods, they shall apply.
- B. Notify the Engineer of any planned deviation from these specifications before proceeding so any price changes, or quantity adjustments may be made.

1.06 ACCEPTANCE

- A. Minimum final yield being sought is 5 gallons per minute.
- B. Water shall be clear and free of sand.
- C. Work covered by this section will not be accepted until records and testing connected with the work have been completed satisfactorily.

PART 2 - PRODUCTS

2.01 WELL CASING

- A. Steel Well Casing
 - 1. Conform to ASTM A53, Grade A or Grade B, Type E, electric resistance welded or Type S, seamless.
 - 2. Each length of pipe shall be clearly marked.
 - a. Markings shall include manufacturers name, type of pipe, ASTM number and pipe length.
 - b. Mill certificates shall be supplied if the Engineer deems the casing pipe or markings to be of questionable condition.
 - 3. Pipe shall be clean and free of oil, grease, rust, or other detrimental materials.
 - 4. Pipe shall meet the following requirements:

Nominal Diameter (inches)	Internal Diameter (inches)	Nominal Wall Thickness (inches)	Minimum Weight (lbs per lin. foot)
4	4.026	0.237	10.79
5	5.047	0.258	14.62
6	6.065	0.280	18.97
8	7.981	0.322	28.55

B. Plastic Well Casing

1. Conform to ASTM F480 and be SDR 21, 200 psi manufactured of PVC 1120 or 1220 resin.

2.02 WELL SCREEN

A. General

1. Well screen openings shall be sized to permit the maximum practical sand free yield after development.
2. Install a maximum of 4 feet of screen unless otherwise directed by the Engineer.

B. Stainless Steel Screen

1. Continuous slot design, with outer windings and internal longitudinal bars.
2. Both members shall be type 304 stainless steel conforming to ASTM A276.
3. Screen shall be a commercial product, equal to screens manufactured by The Johnson Division, Universal Oil Products Company, St. Paul, MN or Howard Smith of Houston, TX.

C. PVC Screen

1. Unobstructed V-type slot design with an SDR 21 rating, minimum stiffness of 170, conforming to ASTM F480.
2. Screen shall meet 1600-pound tensile pull test.
3. Screen shall be a commercial product, equal to products manufactured by Certainteed Pipe and Plastics Group, Valley Forge, Pennsylvania.
4. Butt-type couplings shall be the same materials as the screens.

2.03 GRAVEL AND SAND PACK

- A. Well rounded uniform grains of washed quartz or approved equal.
- B. Weight loss by the acid test shall be less than 20%.
- C. Gradation specified by the manufacturer of the well screen based on the submitted gradation of the water bearing formation or as specified by the Engineer.

2.04 GROUT

- A. Conform to local or state codes

2.05 DRILLING FLUID (MUD ROTARY METHOD)

- A. Conform to standard accepted well drilling practice for water wells.

2.06 HYDROFRACTURING PLAN AND METHOD

- A. Conform to standard accepted well drilling practice for hydrofracturing of water wells.
- B. List equipment to be used.
- C. Include operating pressures and pumping capacity of equipment.
- D. Plan for the hydrofracturing of the well(s) (estimated pressure, etc).

PART 3 - EXECUTION

3.01 GENERAL

- A. Drill well in the location shown on the site plan, a minimum of 50 feet from the proposed drainfield, and in the location designated by the Engineer or the Owner's Representative.

3.02 DRILLING

- A. General
 - 1. State license requirements shall be met.
 - 2. Locate all existing underground utilities.
 - 3. Prevent contaminated water from entering the well.

4. Minimum final yield of 5 gallons per minute for the home is being sought, however, well should always be developed to its maximum yield.
 - a. Contact Engineer prior to abandoning wells producing less than 5 gpm.
 - b. If well produces less than 5 gpm and the Contractor recommends hydrofracturing the well, contact the Engineer for approval.
5. Drill and case wells at the size specified in the bid schedule.
6. Locate wells as indicated on the plans or as staked by the Engineer.
7. Drill wells no deeper than the depth specified, unless approved by the Engineer.
8. If satisfactory yield is obtained at a lesser depth, terminate drilling and develop at that depth.
9. Drill in accordance with local or state codes.

3.03 CASING

- A. Install the materials and sizes stated on the bid schedule.
- B. Install casing in wells to a depth appropriate for the formation type and minimum yield specified.
- C. Connect casing lengths with either screwed couplings or approved welds.
 1. Keep surfaces to be welded free from local scale, rust, grease, paint and other foreign materials.
 2. Ends to be welded shall be factory cut and beveled.
 3. Welding will not be allowed when the base metal temperature is below 0 degrees Fahrenheit.
 4. Heat areas within 3 inches of the weld when the base metal temperature is between 0 and 32 degrees Fahrenheit.
 5. Casing sections having twists, bends, offsets, and openings will not be accepted.
 6. Make all joints watertight.
- D. Do not drive plastic well casing.

- E. PVC casing depths are limited to 300 feet and dependent on the formations encountered.
 - 1. Prevent PVC damage or scratching by properly handling PVC casing.
 - 2. Solvent weld all PVC casing joints.
 - 3. Follow manufacturer's recommendation for solvent welding joints.
 - 4. No leaks will be permitted at any joints.
- F. If the top of the casing is torch cut, grind all rough surfaces smooth.
- G. Plumbness and Alignment
 - 1. Maximum deviation from vertical in any 100 feet of depth is 2 1/2 inches.
 - 2. Conduct a straightness and alignment test on all questionable wells after casing.
 - a. The test will consist of running piece of pipe 40 feet long whose diameter is 1/4 to 1/2 inch smaller than the inside diameter of the inside of the of the casing to the bottom of the well.
 - b. No payment will be made for testing procedure or materials.
 - 3. If the test pipe binds, is bent as a result of testing procedure or does not pass through the well casing freely the well will not be accepted and no payment will be made.

3.04 SCREENING AND GRAVEL PACK

- A. Install the materials and sizes stated on the bid schedule.
- B. Install well screens in unconsolidated formations (and gravel pack if required), after sufficient yield is obtained from the water bearing formation in accordance with local or state codes.
 - 1. If pull back method is used and screen is not welded to the casing, provide screen with a minimum 18-inch section of riser pipe with a neoprene type packer.
- C. Install PVC well screens using the open hole method.

1. Fit PVC well screen with an approved rubber type packer or by solvent welding a threaded adapter on to the PVC casing and threading the screen onto the adapter.
- D. Fill the drill hole with approved material if the bottom is deeper than the screened area.

3.05 WELL DEVELOPMENT

- A. Develop the well using a method that extracts the maximum practical quantity of drilling mud, fine sand, silt or other fine material.
1. Maximum allowable sands and fine material: 2 ppm (by weight).
- B. Acceptable development methods include surge plungers, compressed air or high velocity jetting.
1. Bailing or pumping is not acceptable.
 2. Compressed air must be delivered at a minimum rate of 75 cfm at a minimum pressure of 100 psi.
- C. Conduct development so as to prevent settlement of the stratum above the water bearing formation.
- D. High velocity jetting with phosphates may be required.
1. Follow established procedures for this type of development.
- E. Duration of development: one hour unless otherwise directed by the Engineer.

3.06 GROUTING

- A. Conform to local or state codes.

3.07 TESTING FOR YIELD AND DRAWDOWN

- A. Conform to local or state codes.
- B. Test pump wells at 15 gpm or maximum well capacity, whichever is less, unless otherwise directed.
- C. Do not use the actual pumps to be installed in the well for the test pump operation.

- D. Duration of drawdown test: one hour, unless otherwise directed by the Engineer.
 - 1. Take drawdown and pump discharge measurements every 5 minutes for the first half-hour.
 - 2. Take drawdown and pump discharge measurements every 10 minutes for the remainder of the test.
- E. Record recovery measurements immediately upon completion of test pump for one hour total, unless otherwise directed by the Engineer.
 - 1. Take recovery readings every minute for the first 10 minutes.
 - 2. Take recovery readings every 5 minutes for the remainder of the hour.
- F. Remove all temporary-pumping facilities at the conclusion of test pumping.
- G. If well yield is less than 5 gpm
 - 1. Contact Engineer immediately.
 - 2. Engineer will determine if the well is acceptable. If well is not acceptable, go to Section 3.11 of this specification.
- H. Submit results of pump test to Engineer.

3.08 DISINFECTION

- A. Upon completion of test pumping and construction, thoroughly clean the well of all foreign material (i.e. cement, oil, grease, joint dope, scum, etc.)
- B. Disinfect well with a chlorine solution
 - 1. Prepare solution prior to injection into well.
 - 2. Mix volume and strength such that a minimum concentration of 50 ppm of free residual chlorine is obtained in all parts of the well for a minimum of 24 hours after injection.
 - 3. Flush casing above static water level with solution.

3.09 CHEMICAL AND BACTERIOLOGICAL ANALYSIS

- A. Take bacteriological and chemical samples immediately after disinfection and flushing of each well.

- B. Submit samples to State Department of Health or Indian Health Service approved lab.
 - 1. Provide copy of results within 10 days of receipt of the report.
 - 2. If a sample tests positive, notify Engineer immediately and repeat chlorination of the well until a sample tests negative.
 - 3. Conform to sampling and preservation requirements of laboratory.
 - 4. Parameters to be analyzed:
 - a. Bacteriological
 - b. Total Hardness
 - c. Nitrate
 - d. Total Iron
 - e. Manganese
 - f. Arsenic
- C. Submit chemical analysis results to Engineer within 30 days of completion of test pumping.

3.10 CAPPING

- A. Conform to requirements of Section 02512 for well cap.
- B. Temporary caps may be used, as approved by the Engineer, if individual water system is being completed at a later date. Caps shall prevent contamination of well by surface water.

3.11 WELL LOG

- A. Keep daily log of each hole drilled.
- B. File an official construction report, using state approved form, with the designated state agency within 30 days from when well is completed.
 - 1. Submit a copy to the Engineer.

3.12 UNACCEPTED DRILLED WELLS

- A. Drilled wells will not be accepted due to insufficient capacity, unsatisfactory chemical or bacteriological quality, poor alignment, loss of tools or any other cause.
- B. Obtain Engineer's approval prior to abandoning wells.

C. Well abandonment shall be in accordance with Section 02528.

END OF SECTION

SECTION 02528 WELL ABANDONMENT

PART 1 - GENERAL

1.01 SUMMARY

- A. This section includes the proper abandonment of wells including well holes, submersible pumps, drop pipe, and submersible cable.

1.02 RELATED WORK

- A. Section 01119 – Revisions to Specifications
- B. Section 02525 – Individual Well Drilling

1.03 REFERENCES

- A. Applicable state codes for MN.

1.04 SUBMITTALS

- A. Method of abandonment.

PART 2 – PRODUCTS

2.01 MATERIALS FOR WELL ABANDONMENT

- A. Conform to applicable state and local regulations.
- B. Wells in Unconsolidated Formations
 - 1. Bentonite Grout
 - 2. High Solids Bentonite Grout
 - 3. Neat Cement Grout
 - 4. Concrete Grout-**Approved only for dry portion of hole.**
- C. Dug Well in Unconsolidated Formation
 - 1. The following may be used if dug well is ≥ 16 inches diameter, < 200 feet deep and contains < 20 feet of water
 - a. Uniformly mixed dry bentonite powder or granular bentonite and sand in a ratio of one part bentonite to five parts sand; or

- b. Clean unconsolidated materials with a permeability of 10^{-6} centimeters per second or less; or
 - c. Concrete grout
 - 2. Sealing materials must have sufficient bearing strength to prevent subsidence and support traffic or building loads.
- D. Wells or Borings in Rock
 - 1. Neat cement grout
 - 2. The following materials may be used; if a cavern more than twice the bore hole diameter exists, formation is sandstone that is blasted and bailed, or grout level fails to rise after more than one cubic yard of grout or the amount necessary to fill ten vertical feet of hole is pumped into the well.
 - a. Mixture of gravel or stone aggregate not larger than one-half inch and cement or concrete grout. Mixture Ratio not to exceed five parts aggregate to one part grout.

PART 3 - EXECUTION

3.01 EXISTING CASED WELLS

- A. Measure and record static water levels prior to closure.
- B. Measure and record well depth, diameter, and casing material prior to closure.
- C. Pull pump and drop pipe from existing wells prior to closure.
 - 1. Well pump and drop pipe is the property of the homeowner.
- D. Cut casing off 2 feet below ground surface.
- E. Fill well, including an open annular space, with appropriate material.
 - 1. Casing with an open annular space must be:
 - a. Grouted in place; or
 - b. Removed (bottom of casing must remain submerged in grout if in collapsing layer); or
 - c. Perforated a minimum of one-half square inch of open area in each foot of casing through entire length of confining layer; or
 - d. Ripped a minimum of five feet for every 20 feet of casing through the entire length of confining layer

3.02 METHODS OF ABANDONMENT

A. Wells in Unconsolidated Formations

1. Pump grout through tremie pipe from bottom of well to within two feet of established ground surface.
 - a. Tremie pipe end shall remain submerged in grout while grouting
2. Clean sand or cuttings, equal to the volume of grout, may be poured into well, at rate which prevents bridging, while pumping grout through tremie pipe.

B. Dug Wells in Unconsolidated Formations

1. If dug well is ≥ 16 inches diameter, < 200 feet deep and contains < 20 feet of water.
 - a. Sealing materials shall be poured into well at a rate to prevent bridging

C. Wells or Borings in Rock

1. Neat cement grout shall be pumped through tremie pipe
 - a. Tremie pipe end shall remain submerged in grout while grouting.
2. The following methods may be used; if a cavern more than twice the bore hole diameter exists, formation is sandstone that is blasted and bailed, or grout level fails to rise after more than one cubic yard of grout or the amount necessary to fill ten vertical feet of hole is pumped into the well.
 - a. Pour gravel or stone aggregate, at a rate to prevent bridging, while Simultaneously pumping grout; or
 - b. Pump gravel and grout mixture; or
 - c. Place alternating layers of grout and aggregate.
 - (1) Layers shall not exceed 10 feet in thickness, except in blasted and bailed sandstone formations
 - (2) Aggregate shall not be placed in confining layer
 - (3) Grout shall be pumped through a tremie pipe
 - (4) Aggregate shall be poured at a rate to prevent bridging

3.03 RECORDS

- A. File abandonment reports with designated state agency and provide a copy to the Project Engineer within 30 days.
- B. Provide static water level records, well depths, diameters, and casing materials to Project Engineer within 30 days.

END OF SECTION

This Page Intentionally Left Blank

**SECTION 02920
TOPSOILING, SEEDING, FERTILIZING, AND MULCHING**

PART 1 - GENERAL

1.01 SUMMARY

- A. This section includes topsoiling, seeding, fertilizing, and mulching areas disturbed by construction activities.

1.02 RELATED WORK (as applicable)

- A. Section 02310 – Grading
- B. Section 02370 – Temporary Erosion and Sediment Control

1.03 REFERENCES

- A. Minnesota Department of Transportation – Seeding Manual 2007 Edition.

1.04 SUBMITTALS

- A. Topsoil
- B. Seed Mixture and Application Rate Data
- C. Mulching Material

PART 2 - PRODUCTS

2.01 TOPSOIL

- A. Natural loam, sandy loam, silt loam, silty clay loam, or clay loam humus-bearing soils adapted to the sustenance of plant life.
- B. Neither excessively acid nor excessively alkaline.

2.02 FERTILIZER

- A. Use a 20-10-10 mixture of 20% Nitrogen, 10% Phosphorous, and 10% Pot Ash.

2.03 SEED MIXTURE

- A. Use Minnesota DOT seed mixture #240 or other Engineer accepted seed mixture for well drained sandy soils:

Minnesota DOT Seed Mixture #240

13%	Smooth Brome Grass
27%	Kentucky Bluegrass
13%	Canadian Bluegrass
2.5%	Switch Grass
4.0%	Slender Wheat-grass
7.0%	"Reliant II" Hard Fescue
20%	Perennial Rye-grass
2.5%	Sand Dropseed
3.5%	Little Bluestem
7.0%	Red Clover
0.5%	Purple Prairie Clover

- B. Use Minnesota DOT seed mixture #250 or other Engineer accepted seed mixture for average loam, heavy clay or predominately moist soils:

Minnesota DOT Seed Mixture #250

14%	Smooth Brome Grass
29%	Kentucky Bluegrass
14%	Canadian Bluegrass
3.0%	Switch Grass
21%	Perennial Rye-grass
3.0%	Timothy
3.0%	Redtop
6.0%	Creeping Alfalfa
3.0%	White Clover

2.04 MULCHING MATERIAL

- A. Straw or hay

PART 3 - EXECUTION

3.01 TOPSOIL

- A. After grading is completed, spread stockpiled topsoil over all disturbed areas, excluding those where another type of finished surface is being provided.

3.02 FERTILIZING

- A. Work soil to be seeded until soil is reasonably even and loose.
- B. Fertilize all topsoiled areas using 20-10-10 fertilizer at an application rate of 400-600 pounds per acre.

3.03 SEEDING

- A. Sow seed using either equipment suited to that purpose or scatter seed uniformly over area with hand seeders when the weather is sufficiently quiet to prevent seeds from blowing away. Use an appropriate method and rate as directed by the Mn/DOT Seeding Manual.
- B. Lightly rake soil to cover the seed with approximately $\frac{1}{4}$ inch of soil.

3.04 MULCHING

- A. Place hay or straw mulching on seeded area loose enough to allow some sunlight to penetrate and air to circulate but thick enough to shade the ground, conserve soil moisture, and prevent/reduce erosion.
- B. Do not perform mulching activities during periods of excessively high winds, which would preclude the proper placing of the mulch.
- C. Apply straw or hay uniformly over the disturbed area to a loose depth of $\frac{1}{2}$ to $1\frac{1}{2}$ inches using $1\frac{1}{2}$ to 3 tons of mulch per acre.
- D. Immediately after spreading, anchor mulch using a mulch tiller consisting of a series of dull flat discs with notched edges or other approved equipment.
- E. Anchor mulch to a depth of approximately $1\frac{1}{2}$ to $2\frac{1}{2}$ inches in the soil.

3.05 QUALITY CONTROL

- A. All work necessary for topsoiling, fertilizing, seeding and mulching shall be completed to insure adequate re-establishment of vegetation.
- B. The Contractor is responsible for re-establishing vegetation.

END OF SECTION



This Page Intentionally Left Blank